

# Z82

## 4MP Outdoor Zoom Dome with D/N, Adaptive IR, Extreme WDR, SLLS, 4.4x Zoom Lens



- 4 Megapixel
- Day & Night with Superior Low Light Sensitivity and Adaptive IR LED
- Extreme WDR
- H.265 Compression
- Wide Angle

### ► Specifications

#### Device

Product Type	Zoom Dome
Maximum Resolution	4MP
Application Environment	Outdoor
Description	4MP Outdoor Zoom Dome with D/N, Adaptive IR, Extreme WDR, SLLS, 4.4x Zoom lens
Image Sensor	Progressive Scan CMOS
Sensor Size	1/3 "
Day / Night	Yes
Low Light Sensitivity	Superior
Minimum Illumination	Color: 0.02 lux; B/W: 0 lux (IR LED on)
Mechanical IR Cut Filter	Yes
IR LED	Adaptive IR LED
IR Working Distance	30m
S/N Ratio	52 dB

#### Lens

Focal Length	Zoom, f2.7-12mm
--------------	-----------------

Aperture	F1.4
Zoom Ratio	4.4x optical zoom
Zoom Application	Camera Installation
Focus	Auto focus
Lens Mount	Board mount
Horizontal Viewing Angle	91° - 27°
Vertical Viewing Angle	67.4° - 14.2°
Viewing Angle Adjustment	Pan: 0°-360°, Tilt: 15°-90°, Rotation: 0°-360°

## Video

Compression	H.265, H.264 (Baseline/ Main/ High profile), MJPEG
Maximum Frame Rate vs. Resolution	20 fps at 2592 x 1520 25 fps at 2560 x 1440 30 fps at 2048 x 1520 30 fps at 1920 x 1080
Multi-Streaming	Simultaneous triple streams
Wide Dynamic Range	Extreme WDR (120 dB)
Image Enhancement	White Balance, Brightness, Saturation, Contrast, Sharpness, Automatic gain control, Defogging
Digital Noise Reduction	2D + 3D DNR
Privacy Mask	8 configurable regions
Text Overlay	Yes
Built-in Analytics	Tampering Detection
Image Orientation	Flip, Mirror, Rotation (Corridor mode)

## Audio

Audio Type	1-way, Built-in Microphone
------------	----------------------------

## Network

Network Protocol & Service	IPv4, TCP, UDP, DHCP, HTTP, HTTPS, DNS, DDNS, NTP, RTP, RTSP, RTCP, SMTP, FTP, IGMP, ICMP, ARP, UPnP, QoS, SNMP, IEEE 802.1X
Ethernet Port	1 x Ethernet (10/100 Base-T), RJ-45 pigtail connector

## Integration

ONVIF Compliant	Yes, Profile S
Web Browser	IE 11

## Interface

Local Storage	MicroSDHC Memory Card Slot (card not included, up to 128GB, Kingston or Sandisk only)
Operating Button	Reset Button

## General

Power Source	DC 12V, PoE Class 3 (IEEE802.3af)
Power Consumption	8.16 W (PoE)
Weight	670g (1.48lb)

Dimensions	(Ø x H): 129mm x 110mm (5.08" x 4.3")
Environmental Casing	Weatherproof (IP68), Vandal proof (IK10)
Operating Temperature	-40°C ~ 60°C (-40°F ~ 140°F)
Approvals	CE, FCC, EAC, IP68, IK10
Real-time Clock (RTC)	Yes
Warranty	2 Year(s). For extended warranty offering, see <a href="http://www.acti.com/support/warranty">http://www.acti.com/support/warranty</a>

## ► Photo Indication





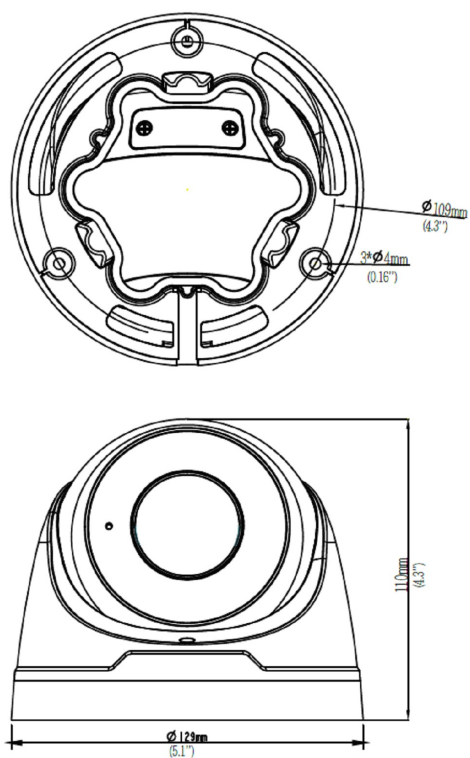

## ► Dimension Diagram



Unit: mm [inch]

## ▶ Related Products

### Mounting Accessories - Camera Mount

PMAX-0128		Pendant Mount (for Z85, Z86, Z87, Z810)
PMAX-0323		Wall Mount with Built-in Junction Box (for Z91, Z94, Z95,Z97,Z98, Z77, Z81, Z82, Z85, Z86, Z87, A7X)
PMAX-0527		Pole Mount (for Z4x, Z710, Z8x, Z9x, A7x), supports 2.64" to 5" Poles
PMAX-0532		Pole Mount (Z710, Z8x, Z9x, A7x), supports 2.6" to 5" Poles
PMAX-0713		Junction box (for Z81, Z82, Z85, Z86, Z87)

**Note:** Some mounting accessories may need additional accessories for installation. Please check [www.acti.com/mountingselector](http://www.acti.com/mountingselector) for more information.

### Power Supply Accessories - Power Adapter

PPBX-0012		Power Adapter AC 100~240V (US), for A3x, A4x, A88, A9x, Z31, Z8x, Z9x
PPBX-0013		Power Adapter AC 100~240V (EU), for A3x, A4x, A88, A9x, Z31, Z8x, Z9x
PPBX-0014		Power Adapter AC 100~240V (UK), for A3x, A4x, A88, A9x, Z31, Z8x, Z9x

### Power Supply Accessories - PoE Injector

PPOE-0002		PoE Injector IEEE 802.3af compliant, AC 100~240V, with universal connectors
-----------	---	---