



I-8094F-G / I-9094F

High-speed 4-axis Motion Control Module
with FRnet Master

Introduction

The **I-8094F** and **I-9094F** are 4-axis stepping/pulse-type servo motor control modules that can be used on the programmable automation controller (PAC) series provided by ICP DAS, and are suitable for general-purpose motion applications. The I-8094F/I-9094F have the full functions of the I-8094/I-9094 with the addition of an FRnet port, which allows the fast remote I/O of the module to be expanded easily. This two-wired FRnet can automatically scan its 128 DI and 128 DO channels within a period of 2.88 ms.

In addition to their wide speed range, these intelligent motion controllers also have a variety of motion control functions built in, such as 2/3-axis linear interpolation, 2-axis circular interpolation, T/S-curve acceleration/deceleration, numerous synchronous actions, automatic homing, and others. A major advantage is that the majority of the I-8094F/I-9094F motion control functions are performed by the high-performance motion ASIC with little load on the processor. While driving the motors, the motion status, and the status of the other I/O channels on the PAC modules, can still be monitored.

As the CPU loading requirements of the I-8094F/I-9094F is minimal, one or more motion modules may be used with a single PAC controller. ICP DAS also provides a wide range of functions and examples that can be used to reduce the need for additional programming, making it a highly cost-effective solution for motion control application developers.

Features

- Independent 4-axis motion control
- Support for hand wheel and jog functions
- 2/3-axis linear / 2-axis circular interpolation function
- Continuous interpolation function
- Programmable T/S-curve acceleration and deceleration
- A maximum pulse output rate of 4 Mpps for each axis
- Pulse Output Types: CW/CCW or PULSE/DIR
- 32-bit encoder counter for each axis
- Encoder Pulse Input Types: A/B Phase or Up/Down
- Programmable automatic homing for each axis
- Position comparison management and software limits
- A wide range of synchronous actions (event-triggered actions)
- Expandable Remote I/O: 128 DI and 128 DO via a two-wire FRnet interface



Specifications

Model	I-8094F-G	I-9094F
General		
Number of Axes	4	
Pulse Output Rate	4 MHz (Max.)	
Command Type	Pulse Command	
Resolution	32-bit	
Pulse Output Mode	CW/CCW, PULSE/DIR	
Operation Mode	Semi-closed Loop	
Linear Interpolation	Any 2 to 3 of 4 axes	
Circular Interpolation	Any 2 axes	
Speed Curve Profile	T/S-curve	
Motion Relative I/O	Home, LMT+/-, NHOME, EMG, INP, ALM, SVON	
Synchronous Action	10 activation factors and 14 actions	
Ring Counter Mode	32-bit	
Position Control Mode	Incremental mode and absolute mode	
Position Compare Trigger	10 KHz	
Encoder Interface	A/B Phase, Up/Down	
Encoder Counter	32-bit	
Encoder Counting Rate	4 MHz (Max.)	
Digital Input Channels	Expandable : 128 DI	
Digital Output Channels	Expandable : 128 DO	
I/O Isolation (With DN-8468)	2500 Vrms optical isolation	
Connector	68-pin SCSI-II connector	
Power Consumption	+5 V @ 500 mA	
Environmental		
Operating Temperature	-20 ~ +75°C	
Storage Temperature	-30 ~ +85°C	
AmbientRelativeHumidity	5 ~ 90% RH, non-condensing	

Features of Motion Function

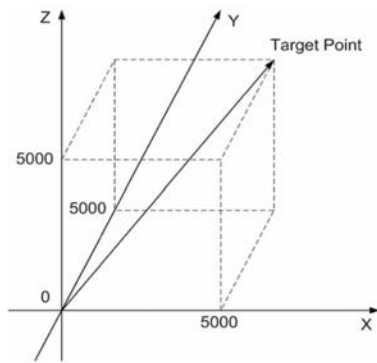

2 or 3-Axis Linear Interpolation

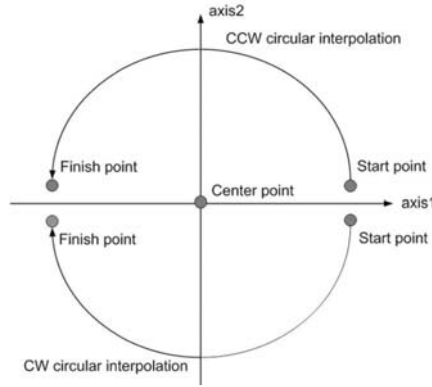

2-Axis Circular Interpolation

8 Segments Continuous Interpolation Motion (Linear+ Circular)

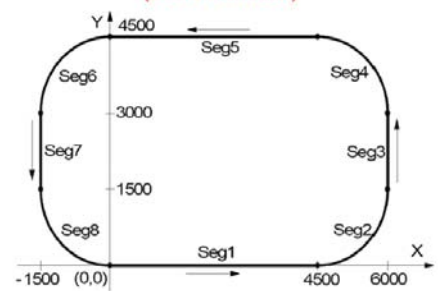

Continuous interpolation

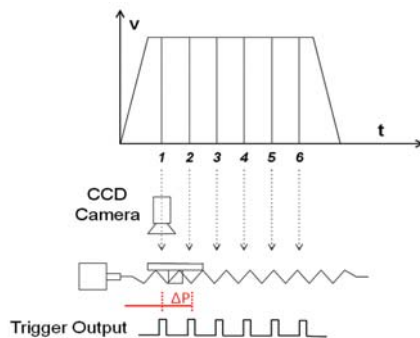

High Speed Position Compare

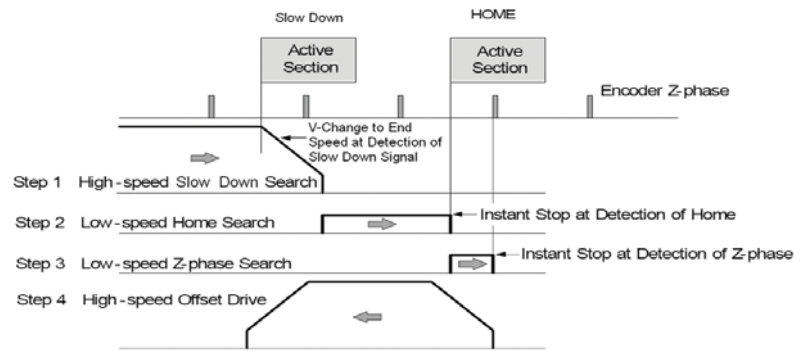

4 Steps Automatic Home Searching

Dimensions (Units: mm)

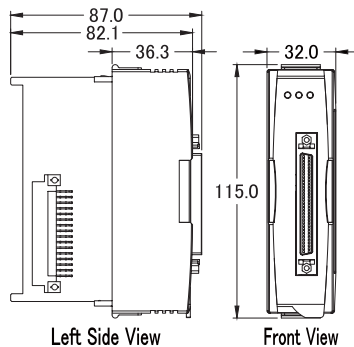

I-8094F-G

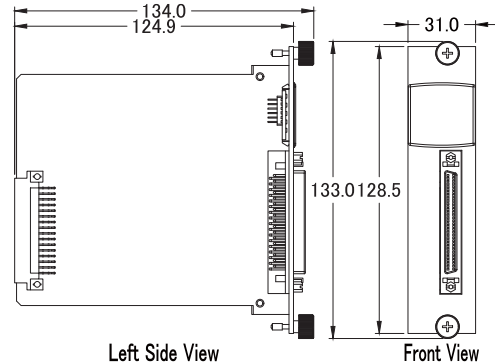

I-9094F

Ordering Information

I-8094F-G	High-speed 4-axis Motion Control Module with FRnet Master (For XP-8000/WP-8000 PAC)
I-9094F	High-speed 4-axis Motion Control Module with FRnet Master (For XP-9000/WP-9000 PAC)

Accessories

DN-8468UB	Photo-isolated Universal Snap-on Wiring Terminal Board
DN-8468GB	Photo-isolated General Purpose Wiring Terminal Board
DN-8468MB	Photo-isolated Snap-on Wiring Terminal Board for Mitsubishi MELSERVO-J2 Servo Amplifier
DN-8468PB	Photo-isolated Snap-on Wiring Terminal Board for Panasonic MINAS A4/A5 Servo Amplifier
DN-8468YB	Photo-isolated Snap-on Wiring Terminal Board for Yaskawa Sigma II/III/V Servo Amplifier
DN-8468DB	Photo-isolated Snap-on Wiring Terminal Board for Delta ASDA-A Servo Amplifier
DN-8468FB	Photo-isolated Snap-on Wiring Terminal Board for Fuji FALDIC-W Servo Amplifier
CA-SCSI15-H3 CA-SCSI30-H3 CA-SCSI50-H2	68-pin SCSI-II Male-Male Connector Cable, Length 1.5 M / 3.0 M / 5.0 M