

ENR-130

16-Channel Desktop Standalone NVR



- 2-bay Desktop Standalone NVR
- Maximum Number of Video Devices: 16
- Free License: 16
- Video export formats: AVI, RAW
- Event trigger, response and notification
- Workstation, Web Client, Mobile Client

► Solution Diagram

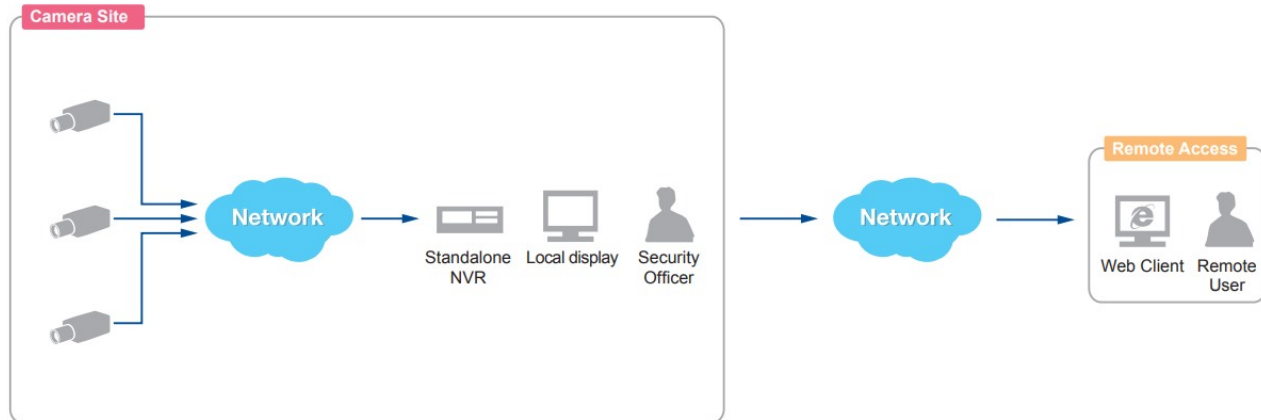

Remote User: Administrator / Supervisor / Manager / Security Officer

► Specifications

Device

Product Type	Standalone NVR
Maximum Resolution	Local: up to 4MP; Remote: up to 10MP
Maximum Number of Cameras	16

Maximum Number of Video Devices	16
Maximum Number of Clients	Local: 1, Remote: 2

License

License required	No
Free License	16

Live View

Display Layout Mode	Local:1,2,4,9,12,16,1+5,1+7,1+12,2+4,2+8, Remote:1,2,4,9,12,16,1+5,1+7,1+12,2+4,2+8
Fisheye Dewarping	Local: No, Remote: Yes
Local Live View performance	Please check "Standalone NVR Performance Validator" (http://www.acti.com/SANVRPerformance)
Digital Zoom	Yes
Event Status	Display event status upon alarm or upon connection loss or recovery between server and client
Instant Playback	Instant Playback in live view window (Remote client)

PTZ

PTZ Control	PTZ Control, Speed Control, 32 preset points
Joystick	USB based joystick supported

Video

Compression	H.264
-------------	-------

Audio

Audio Compression	PCM, G.711
-------------------	------------

Network

Network Protocol & Service	IPv4/v6, TCP, IP, UDP, HTTP, HTTPS, DHCP (Server/Client), PPPoE, RTP, RTSP, DNS, DDNS, NTP, SNTP, ICMP, ARP, SMTP, UPnP, To be available through future firmware upgrade
Ethernet Port	Total ports: 2 port(s) (LAN 1) Non-PoE: 1 port(s), Ethernet (1000 Base-T), RJ-45 connector (LAN 2) Non-PoE: 1 port(s), Ethernet (10/100 Base-T), RJ-45 connector
Security	HTTPS encryption, Password protected user level

Recording

Recording Resolution	12MP, 10MP, 8MP, 6MP, 5MP, 4MP, 3MP, 2MP, 1080p (1920x1080), 720p, CIF, VGA
Scheduled Recording	Yes
Event Recording	Yes
Manual Recording	Yes
Event Speed-up Recording	Yes
Dual Stream Management	Yes
Recording Capability	≥25 fps at 1920x1080 (per channel)
Maximum Recording Throughput	48 Mbps

Search & Playback

Playback Control	Continuous forward and backward playback with speeds 0.5x/1x/2x/4x/8x/16x/32x, pause, stop
Synchronized Playback	16 channels
Video Export	AVI, RAW

Event

Event Trigger	Video motion detection, External device through digital input, Network loss and recovery
Event Response	Play alert sound, E-mail notification with snapshots, Go to PTZ preset point or preset tour, Activate external device through digital output

System

Permission control	Unlimited number of users, Customizable permissions for user groups
Client PC Operating System	Windows 7 SP1, Windows 8.1
Server Operating System	Embedded Linux
Mobile Client Program	Mobile device application (ACTi Mobile Client) supports Live View, PTZ Control, Event/time based search and playback, iPad, Android device
USB	2-Port USB 2.0
Language	Multi-Language
System Status Monitor	Real time status reports on remote browser

Integration

Unified Solution	Fully compatible with ACTi cameras, encoders, central management system, TV wall and intelligent video surveillance software
ONVIF Compliant	Yes, Profile S
Web Browser	IE 11 (Please verify that your computer meets the minimum system requirements for Internet Explorer from Microsoft website.)

Storage

Storage Bay	SATA, Max. 2 Disk(s) (Options to have empty bays, one 4TB or one 8TB storage disk included)
HDD Size	3.5"
Maximum Recording Capacity	14TB x2

Interface

Local Access	USB keyboard & mouse, USB Joystick
Local Display Interface	HDMI x 1,

General

Power Source	DC 12V
Weight	1320g (2.91lb)
Dimensions	(W x H x D): 135mm x 121mm x 251mm (5.3" x 4.8" x 9.9")
Bundled Accessories	Power Adapter
Fan	Yes
Operating Temperature	0°C ~ 40°C (32°F ~ 104°F)
Operating Humidity	10% - 85% RH

Standalone NVR

Remote Access	Workstation, Web Client, Mobile Client
Approvals	CE, FCC, UL (for bundled power adapter)
Warranty	3 Year(s)

► Photo Indication

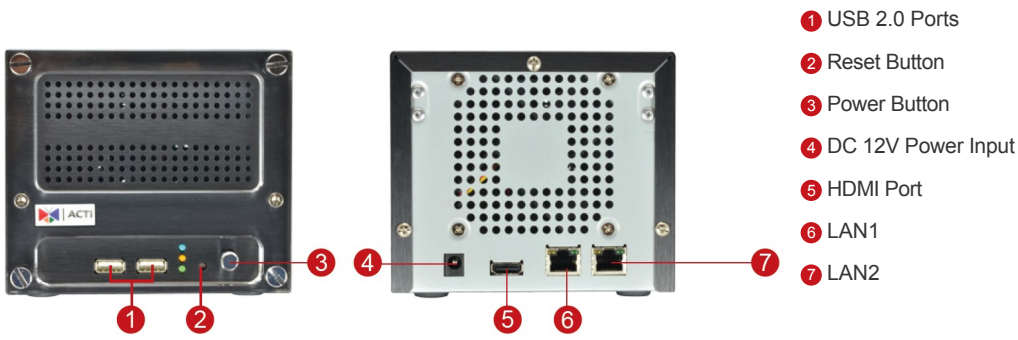

► Dimension Diagram

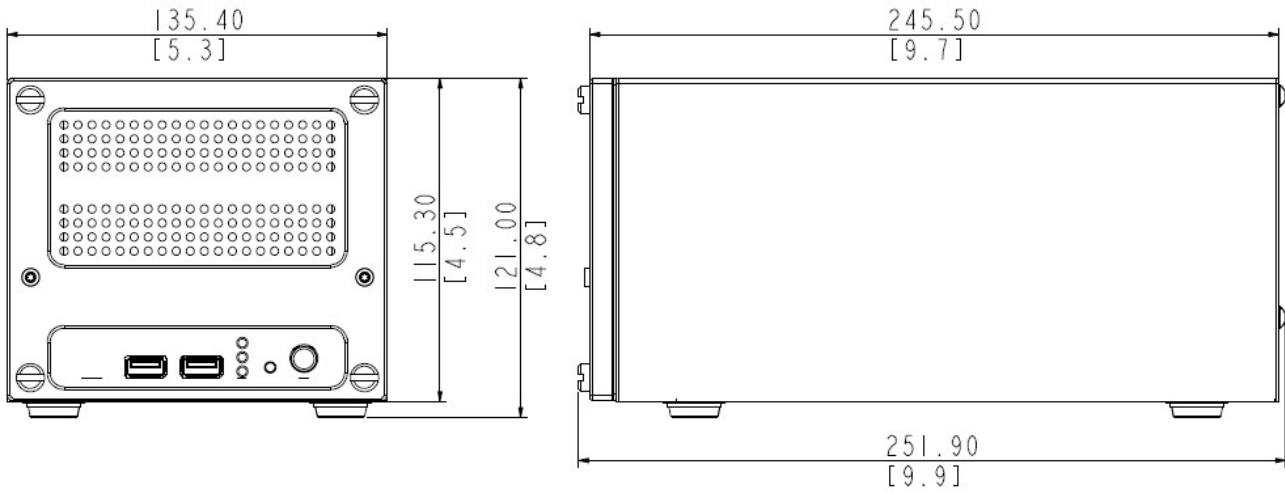

Unit: mm [inch]

▶ Related Products

Power Supply Accessories - Power Adapter

R707-X0003  Power Adapter AC 100~240V with universal connectors (for ENR-110, ENR-120, ENR-130)

Network & Storage Peripherals - Hard Disk

PHDD-2200  WD WD1005FBYZ 1TB 3.5" Hard Disk Drive, 7200 RPM 128 MB Cache (for ENR-0x0P, ENR-110, ENR-120, ENR-130, ENR-22x, ENR-22xP, GNR-310, GNR-320, INR-100, INR-340, INR-430, INR-440, INR-450, INR-460)

PHDD-2301  HGST ULTRASTAR 7K6000 2TB 3.5" Hard Disk Drive, 7200 RPM 128MB Cache (for ENR-1xx, ENR- 0x0P, ENR-22x, ENR-22xP)

PHDD-2501  HGST ULTRASTAR 7K6000 4TB 3.5" Hard Disk Drive, 7200 RPM 128MB Cache (for ENR-1xx, ENR-0x0P, ENR-22x, ENR-22xP)

PHDD-2702  HGST ULTRASTAR 7K6000 6TB 3.5" Hard Disk Drive, 7200 RPM 128MB Cache (for ENR-1xx, ENR-0x0P, ENR-22x, ENR-22xP)

PHDD-2900  WD WD8002FRYZ 8 TB 3.5" Hard Disk Drive, 7200 RPM 128 MB Cache (for GNR-310, GNR-320, INR-100, INR-340, INR-410, INR-430, INR-440, INR-450, INR-460)

PHDD-2A00  WD WD101KRYZ 10TB 3.5" Hard Disk Drive, 7200 RPM 256MB Cache (for ENR-xxx, ENR-xxxP, GNR-330, GNR-410, INR-100, INR-340, INR-410, INR-430, INR-440, INR-450, INR-460, INR-470)

PHDD-2B01  HGST ULTRASTAR 7K6000 12TB 3.5" Hard Disk Drive, 7200 RPM 256MB Cache

PHDD-2E01  HGST ULTRASTAR 7K6000 14TB 3.5" Hard Disk Drive, 7200 RPM 512MB Cache

Controllers - Joystick

PJSK-0100  Apem 100-550-BLK-RF Joystick for PTZ Control (for all ENR, INR, and MNR Series)