

IDS-108F Industrial Ethernet Switch

 [perle.com/products/8-port-industrial-ethernet-switch.shtml](https://www.perle.com/products/8-port-industrial-ethernet-switch.shtml)

8 to 10 port Compact DIN Rail Switch



- 8 port 10/100Base-TX (RJ45)
- 8 port 10/100Base-TX (RJ45) plus 1 or 2 SC/ST fiber ports
- Hazardous Location and Industrial Control Equipment Certification
- Corrosion resistant IP30 aluminum case
- Redundant dual power input 12/24/48 VDC, 18 to 30 VAC
- Overload current and reverse polarity protection
- Industrial operating temperature support up to -40 to 75C

Perle **Industrial-grade Ethernet Switches** are designed to stand up to **extreme temperatures, surges, vibrations, and shocks** found in **industrial automation, government, military, oil and gas, mining and outdoor applications**.

The **IDS-108F is an 8 to 10 port Industrial Ethernet Switch** providing advanced performance to enable real-time deterministic network operation. It requires no configuration and will operate instantly as soon as you power it up.

The IDS-108F comes in a variety of models with 8 copper ports, 8 copper ports plus 1 fiber port or 8 copper ports plus 2 fiber ports. All are **rugged fan-less switches** that are hardened to provide superior reliability in **0 to 60°C**, or harsh extended operating temperatures from **-40 to 75°C**.

Perle has been **designing industrial hardware** for serial ModBus and Profinet to Ethernet conversion environments **for over 35 years** and have used this expertise to design the **toughest Ethernet switches on the market**. Don't trust your critical communications to commercial switch products. Perle Industrial Ethernet switches give you proven assurance that your system will keep running for years to come.

IDS-108F Industrial Ethernet Switch Features

Rugged design for harsh environments

- Corrosion resistant IP30 aluminum case
- UL508A Industrial Control Equipment Safety certified
- Hazardous locations - Class 1/Div2, ATEX Class 1/Zone2

Reliable operation

- Fan-less, no moving parts
- Dual power input. Connect to separate power sources for redundancy.
 - Reverse polarity protection
 - Overload current protection
- Handles vibration and shock conditions found in industrial environments

Real-time Ethernet performance

- Fast wire-speed , store and forward switching, non-blocking architecture
- Auto-sensing for speed and duplex

- Auto-mdi/mdix-crossover works with straight and crossover cables

Power

Dual Power Input	Both inputs draw power simultaneously. If one power source fails, the other live source can, acting as a backup, supply enough power to meet the operational needs of the switch. 12/24/48 VDC Nominal. (9.6 to 60 VDC) 18 to 30 VAC
Power Connector	4-Pin Removable Terminal Block. Grounding screw on metal chassis
Maximum Current Consumption @24 vDC	360 mA
Maximum Power Consumption @24 vDC	8.6 Watts
Overload Current Protection	Reset-able fuse provides overload current protection
Reverse polarity protection	The positive and negative inputs can be reversed providing safe and simple power connectivity.

Access Ports

RJ45	8 shielded RJ45 ports for 10/100Base-TX up to 100 meters (328 ft) Auto-negotiation Auto-MDI/MDIX-crossover for use with either crossover over straight-through cable types Ethernet isolation 1500 V
Fiber port	1 or 2 fixed fiber port models Duplex SC or ST connector Simplex (BIDI, single strand) SC connector PC and UPC type patch cords supported. <ul style="list-style-type: none"> • Multimode 50/125 or 62.5/125 micron fiber cable • Single mode 9/125 micron fiber cable • Multimode 50/125 or 62.5/125 micron fiber cable • Single mode 9/125 micron fiber cable

Fixed Fiber Port Specs	Fiber1 Type	Transmit (dBm)		Receive (dBm)		Power Budget (dB)	Wavelength (nm)	IEEE	Core Size (um)	Modal Bandwidth (MHz *Km)	Maximum Operating Distance
		Min	Max	Min	Max						
	MMF (Duplex SC/ST)	-20.0	-12.0	-31.0	-14.0	11.0	1310	100Base-FX	50	800*	5 Km 3.1 mi

								62.5	500*	4 Km 2.5 mi
								62.5	200	2 Km 1.2 mi
MMF (Simplex SC)	-15.0	0.0	-28.0	-8.0	13.0	1310 / 1550 1550 / 1310	100Base- BX-U 100Base- BX-D	62.5	200	2 Km 1.2 mi
SMF (Duplex SC/ST)	-18.0	-7.0	-32.0	-3.0	14.0	1310	100Base- LX	9	**	20 Km 12.4 mi
SMF (Simplex SC)	-14.0	-8.0	-32.0	-3.0	18.0	1310 / 1550 1550 / 1310	100Base- BX-U 100Base- BX-D	9	**	20 Km 12.4 mi
SMF (Duplex SC/ST)	-5.0	-0.0	-34.0	-3.0	29.0	1310	100Base- EX	9	**	40 Km 24.9 mi
SMF (Simplex SC)	-8.0	-3.0	-33.0	-3.0	18.0	1310 / 1550 1550 / 1310	100Base- BX-U 100Base- BX-D	9	**	40 Km 24.9 mi
SMF (Duplex SC/ST)	-5.0	0.0	-34.0	-3.0	29.0	1550	100Base- ZX	9	**	80 Km 49.7 mi
SMF (Duplex SC/ST)	0.0	5.0	-35.0	-3.0	35.0	1550	100Base- ZX	9	**	120 Km 74.6 mi

* 1db/km multimode fiber cable

** as per ITU-T G.652 SMF specifications

Switch Properties

Standards

- IEEE 802.3 for 10Base-T
- IEEE 802.3u for 100Base-TX and 100Base-FX
- IEEE 802.3x for Flow Control

Processing Type Store and Forward, non-blocking architecture

MAC Address Table Size 8K

Packet Buffer Memory 1 Mbit

Indicators

P1	This green LED is turned on when power is applied to the power #1 input
P2	This green LED is turned on when power is applied to the power #2 input
RJ45 Ethernet	These integrated colored LEDs indicate link, activity and speed for each port.
Fiber Link	Fiber link LED indicates Link and Data Activity

Environmental Specifications

Operating Temperature Ranges	Standard temperature models : 0° C to 60° C (32° F to 140° F). Industrial extended temperature models : -40° C to 75° C (-40 F to 167° F)
Storage Temperature Range	Minimum range of -25° C to 70° C (-13° F to 158° F). -40 C to 85 C (-40 F to 185 F) for industrial extended temperature models
Operating Humidity Range	5% to 90% non-condensing
Storage Humidity Range	5% to 95% non-condensing
Operating Altitude	Up to 3,048 meters (10,000 feet)
Chassis	Aluminum with an IP30 ingress protection rating
Din Rail Mountable	DIN Rail attachment included. Mounts to standard 35 mm DIN rail in accordance with DIN EN 60175. Removable to accommodate optional Panel/Wall mount kit
Maximum Heat Output	29.3 BTU/Hr
MTBF	623,989 hours (without fiber module) 389,062 hours (with 1 fiber module) 347,577 hours (with 2 fiber modules) <i>MTBF Calculation model based on MIL-HDBK-217-FN2 @ 30 °C</i>

Product Weight and Dimensions

Weight	0.32 Kg x 0.7 lbs
Dimensions	35.5 x 111 x 138 mm, 1.39 x 4.37 x 5.43 inches

Packaging

Shipping Weight	0.47 Kg, 1.04 lbs
Shipping Dimensions	170 x 260 x 70 mm, 6.69 x 10.24 x 2.76 inches
Contents Shipped	Industrial Ethernet Switch with DIN Rail attachment Terminal block Installation guide

Standards and Certifications

Safety	<ul style="list-style-type: none"> UL 60950-1 CSA C22.2 No. 60950-1 IEC 60950-1:2005+A1:2009 and EN 60950-1:2006+A11:2009+A1:2010+A12:2011 CE Mark UL508 (Industrial)
EMC Emissions	<ul style="list-style-type: none"> FCC 47 Part 15 Class A ICES-0003 CISPR 22:2008/EN55022:2010 (Class A) EN61000-6-4
EMC Immunity	<ul style="list-style-type: none"> CISPR 24:2010/EN 55024:2010 IEC/EN 61000-4-2 (ESD) : Contact discharge +/- 4kV, Air Discharge +/- 8kV IEC/EN 61000-4-3 (RS) : 80 MHz to 2.7 Ghz ; 10V/m, 800 MHz to 1000 MHz; 20V/m IEC/EN 61000-4-4 (EFT) : DC power line +/- 2 kV, Data Line +/- 2kV IEC/EN 61000-4-5 (Surge) : DC power line, Line/Line +/- 1kV, Line/Earth +/- 2kV, Data Line line/earth +/- 1kV IEC/EN 61000-4-6 (CS) : 150kHz to 80 MHz; 10V IEC/EN 61000-4-8 (Magnetic Field): 30 A/m IEC/EN 61000-6-2 (General Immunity in Industrial Environments)
Industrial Safety	<ul style="list-style-type: none"> UL508 (Safety standard for Industrial Control Equipment) CSA C22.2 No. 142
Hazardous Locations (Hazloc)	<ul style="list-style-type: none"> ANSI/ISA 12.12.01, Class I Division 2 Groups A-D (formerly known as UL 1604) CSA C22.2 No. 213 ATEX Class I Zone 2, EN60079-0,15
Laser Safety	<ul style="list-style-type: none"> EN 60825-1:2007 Fiber optic transmitters on this device meet Class 1 Laser safety requirements per IEC-60825 FDA/CDRH standards and comply with 21CFR1040.10 and 21CFR1040.11.
Environmental	<ul style="list-style-type: none"> Reach, RoHS and WEEE Compliant
Other	<ul style="list-style-type: none"> ECCN: 5A991 HTSUS Number: 8517.62.0050 5 year warranty

IDS-108F with Standard DIN Rail

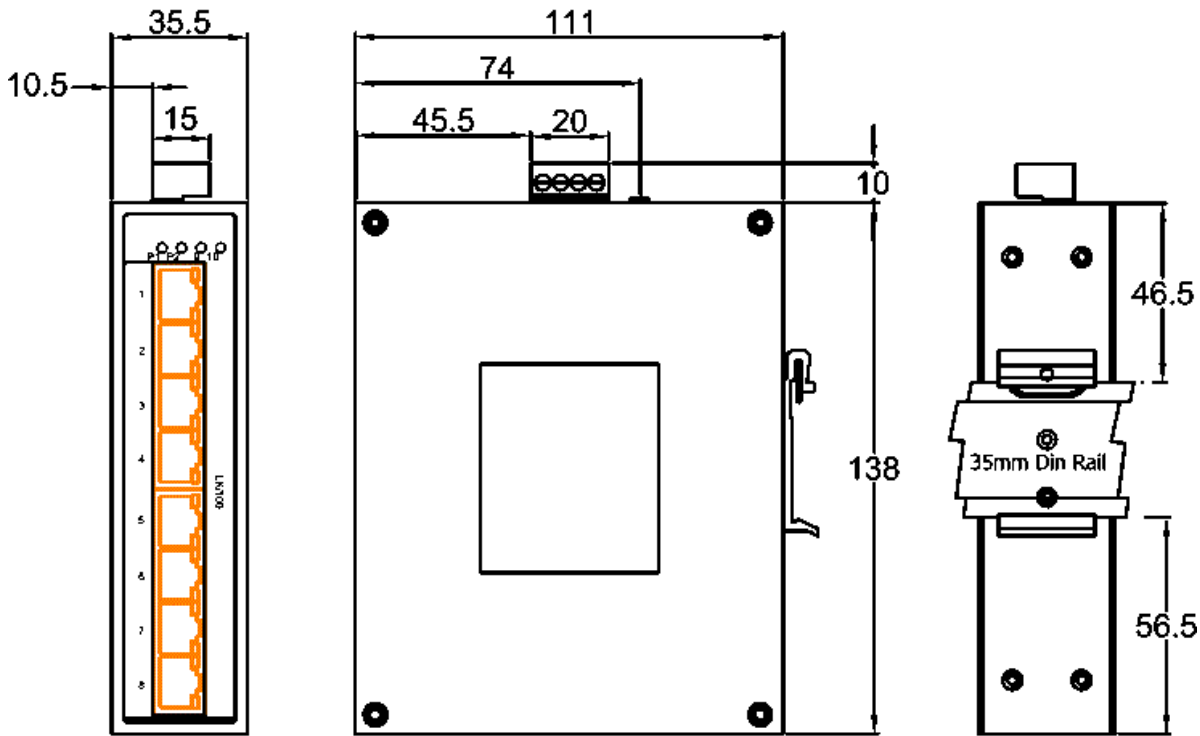
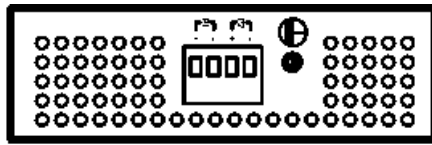

RJ45 Models

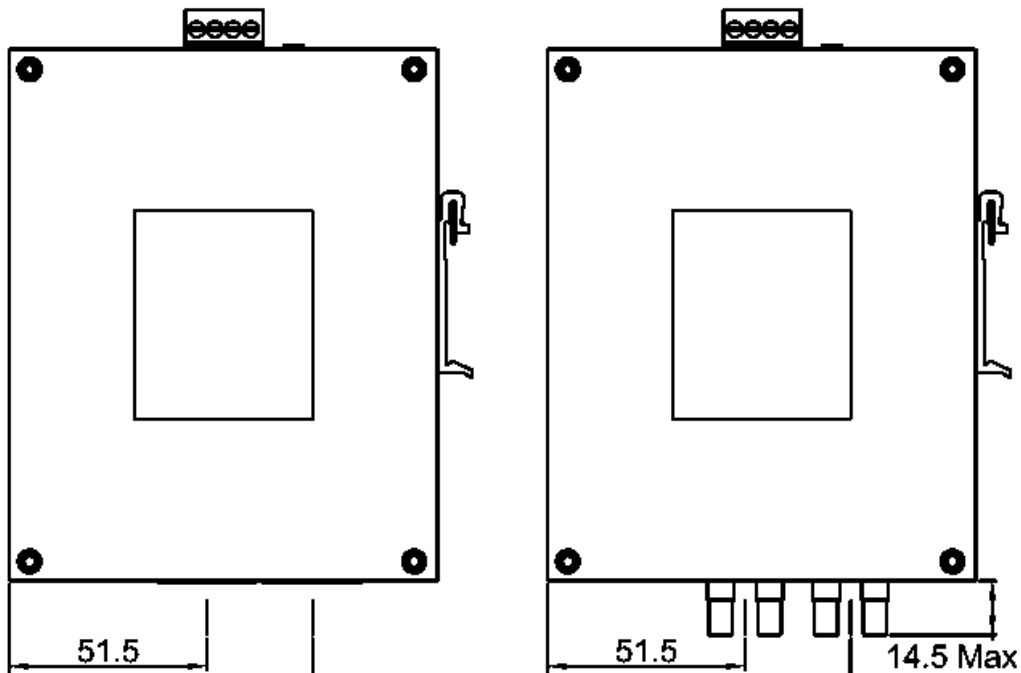
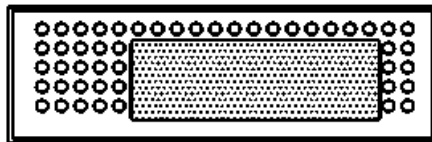

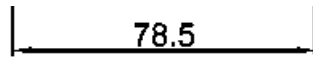
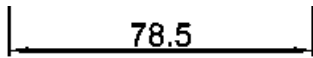

SC Models

ST Models

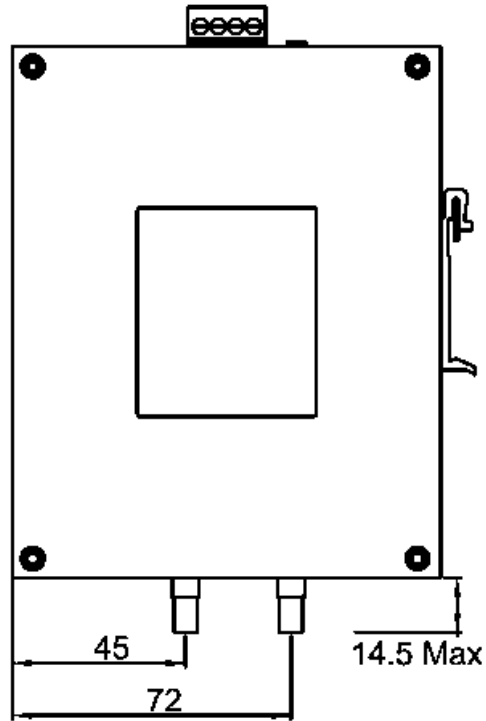
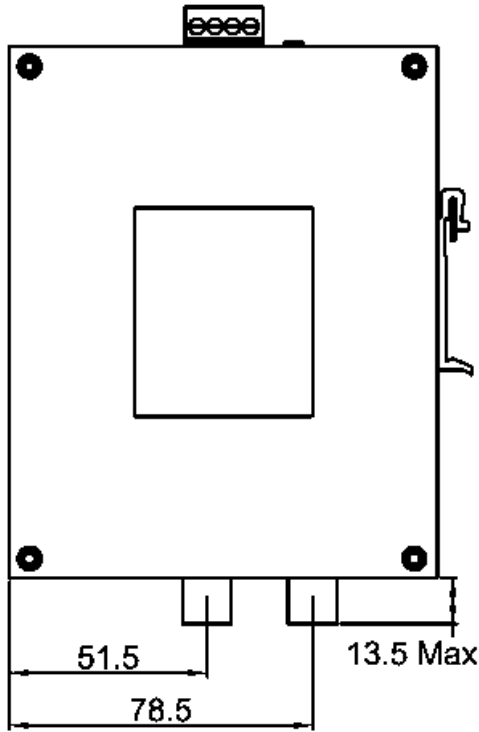
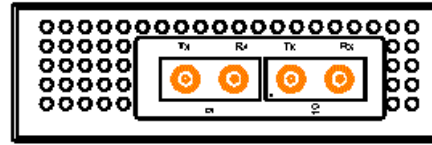
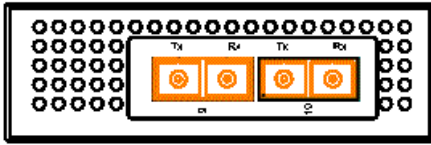

Single Fiber SC Models

Single Fiber ST Models

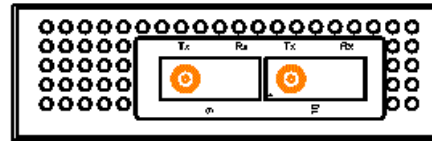
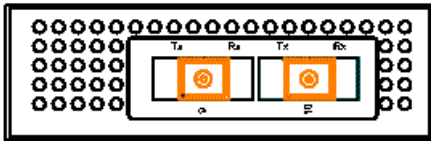

IDS-108F with Optional Wall/Panel Mount Brackets

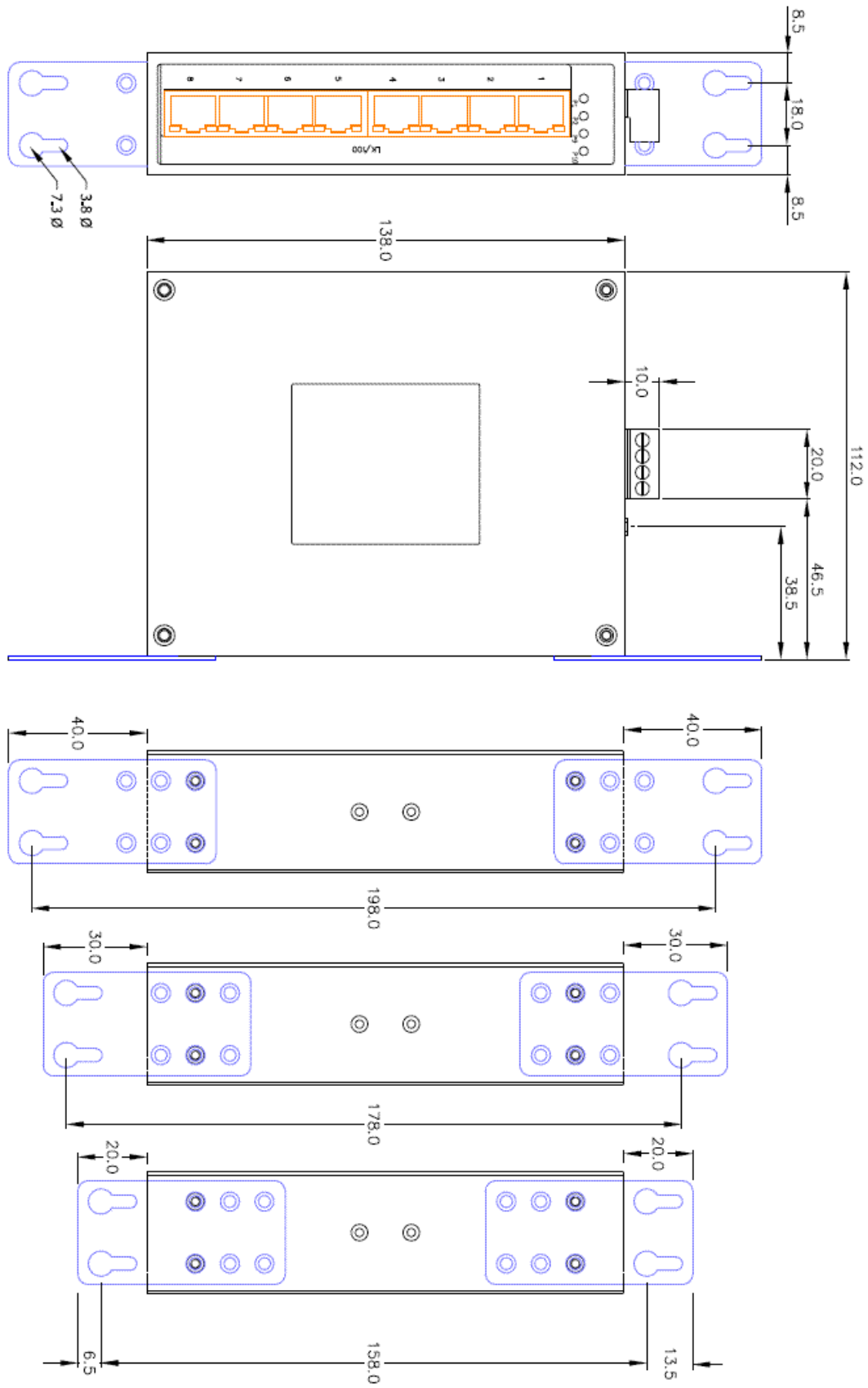

IDS-108F Industrial Switch Diagram

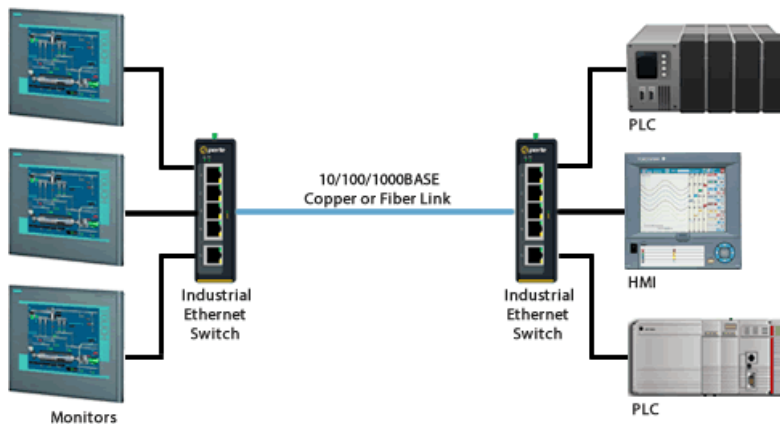

Single Mode / Single Strand (WDM) Fiber

Connecting devices over a single fiber strand (also referred to as “Bi-Directional” BiDi or Simplex)

To reduce costs, or where there are limits on available fiber, Wavelength-Division Multiplexing (WDM) technology may be utilized. WDM uses separate transmit and receive frequencies to communicate on a single fiber strand. WDM technology relies on the fact that optical fibers can carry many wavelengths of light simultaneously without interaction between each wavelength. Thus, a single fiber can carry many separate wavelength signals or channels simultaneously. WDM systems are divided into different wavelength patterns, conventional/coarse (CWDM) and dense (DWDM).

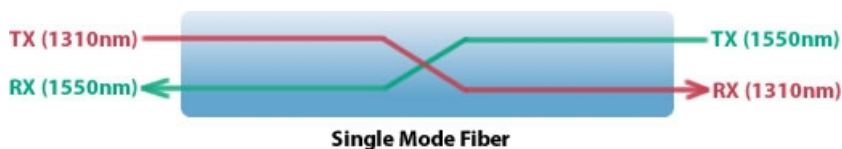

When Single Strand fiber is used, you will need an “Up” side and a “Down” side when interconnecting fiber devices.

Perle offers a wide variety of Single Fiber (“Up/Down”) Ethernet Switches and Media Converters for use with single strand of fiber.

Select a Model to obtain a Part Number – IDS-108F

Std = Standard Temperature models : 0° C to 60° C (32° F to 140° F).
 Ind = Industrial Extended Temperature Models : -40° C to 75° C (-40 F to 167° F)

Duplex Fiber

Model	Temp	RJ45 10/100Base- TX Connectors	Fiber Connector	Transmit (dBm)		Receive (dBm)		Power Budget (dB)	Wavelength (nm)	Fiber Type	Operating Distance
				Min	Max	Min	Max				
IDS-108F	Std	8									
IDS-108F-XT	Ind	8									
IDS-108F- M2SC2	Std	8	1 x Duplex SC	-20.0	-12.0	-31.0	-14.0	11.0*	1310	MMF	5 km* (3.1 mi)
IDS-108F- M2SC2-XT	Ind	8	1 x Duplex SC	-20.0	-12.0	-31.0	-14.0	11.0*	1310	MMF	5 km* (3.1 mi)
IDS-108F- M2ST2	Std	8	1 x Duplex ST	-20.0	-12.0	-31.0	-14.0	11.0*	1310	MMF	5 km* (3.1 mi)

IDS-108F-M2ST2-XT	Ind	8	1 x Duplex ST	-20.0	-12.0	-30.0	-14.0	10.0*	1310	MMF	5 km* (3.1 mi)
IDS-108F-S2SC20	Std	8	1 x Duplex SC	-18.0	-7.0	-32.0	-3.0	14.0	1310	SMF	20 km (12.4 mi)
IDS-108F-S2SC20-XT	Ind	8	1 x Duplex SC	-18.0	-7.0	-32.0	-3.0	14.0	1310	SMF	20 km (12.4 mi)
IDS-108F-S2ST20	Std	8	1 x Duplex ST	-18.0	-7.0	-32.0	-3.0	14.0	1310	SMF	20 km (12.4 mi)
IDS-108F-S2ST20-XT	Ind	8	1 x Duplex ST	-18.0	-7.0	-32.0	-3.0	14.0	1310	SMF	20 km (12.4 mi)
IDS-108F-S2SC40	Std	8	1 x Duplex SC	-5.0	0.0	-34.0	-3.0	29.0	1310	SMF	40 km (25 mi)
IDS-108F-S2SC40-XT	Ind	8	1 x Duplex SC	-5.0	0.0	-34.0	-3.0	29.0	1310	SMF	40 km (25 mi)
IDS-108F-S2ST40	Std	8	1 x Duplex ST	-5.0	0.0	-34.0	-3.0	29.0	1310	SMF	40 km (25 mi)
IDS-108F-S2ST40-XT	Ind	8	1 x Duplex ST	-5.0	0.0	-34.0	-3.0	29.0	1310	SMF	40 km (25 mi)
IDS-108F-S2SC80	Std	8	1 x Duplex SC	-5.0	0.0	-34.0	-3.0	29.0	1550	SMF	80 km (50 mi)
IDS-108F-S2ST80	Std	8	1 x Duplex ST	-5.0	0.0	-34.0	-3.0	29.0	1550	SMF	80 km (50 mi)
IDS-108F-S2SC120	Std	8	1 x Duplex SC	0.0	5.0	-35.0	-3.0	35.0	1550	SMF	120 km (75 mi)
IDS-108F-S2ST120	Std	8	1 x Duplex ST	0.0	5.0	-35.0	-3.0	35.0	1550	SMF	120 km (75 mi)
IDS-108F-DM2SC2	Std	8	2 x Duplex SC	-20.0	-12.0	-31.0	14.0	11.0*	1310	MMF	2 km (1.2 mi)
IDS-108F-DM2SC2-XT	Ind	8	2 x Duplex SC	-20.0	-12.0	-31.0	14.0	11.0*	1310	MMF	2 km (1.2 mi)
IDS-108F-DM2ST2	Std	8	2 x Duplex ST	-20.0	-12.0	-31.0	14.0	11.0*	1310	MMF	2 km (1.2 mi)
IDS-108F-DM2ST2-XT	Ind	8	2 x Duplex ST	-20.0	-12.0	-30.0	14.0	10.0*	1310	MMF	2 km (1.2 mi)
IDS-108F-DS2SC20	Std	8	2 x Duplex SC	-18.0	-7.0	-32.0	-3.0	14.0	1310	SMF	20 km (12.4 mi)
IDS-108F-DS2SC20-XT	Ind	8	2 x Duplex SC	-18.0	-7.0	-32.0	-3.0	14.0	1310	SMF	20 km (12.4 mi)
IDS-108F-DS2ST20	Std	8	2 x Duplex ST	-18.0	-7.0	-32.0	-3.0	14.0	1310	SMF	20 km (12.4 mi)
IDS-108F-DS2ST20-XT	Ind	8	2 x Duplex ST	-18.0	-7.0	-32.0	-3.0	14.0	1310	SMF	20 km (12.4 mi)

IDS-108F-DS2SC40	Std	8	2 x Duplex SC	-5.0	0.0	-34.0	-3.0	29.0	1310	SMF	40 km (25 mi)
IDS-108F-DS2SC40-XT	Ind	8	2 x Duplex SC	-5.0	0.0	-34.0	-3.0	29.0	1310	SMF	40 km (25 mi)
IDS-108F-DS2ST40	Std	8	2 x Duplex ST	-5.0	0.0	-34.0	-3.0	29.0	1310	SMF	40 km (25 mi)
IDS-108F-DS2ST40-XT	Ind	8	2 x Duplex ST	-5.0	0.0	-34.0	-3.0	29.0	1310	SMF	40 km (25 mi)
IDS-108F-DS2SC80	Std	8	2 x Duplex SC	-5.0	0.0	-34.0	-3.0	29.0	1550	SMF	80 km (50 mi)
IDS-108F-DS2ST80	Std	8	2 x Duplex ST	-5.0	0.0	-34.0	-3.0	29.0	1550	SMF	80 km (50 mi)
IDS-108F-DS2SC120	Std	8	2 x Duplex SC	0.0	5.0	-35.0	-3.0	35.0	1550	SMF	120 km (75 mi)
IDS-108F-DS2ST120	Std	8	2 x Duplex ST	0.0	5.0	-35.0	-3.0	35.0	1550	SMF	120 km (75 mi)

* 1db/km multimode 50/125 micron fiber cable

Single Fiber (Simplex / BiDi) Models (Recommended use in pairs)

Simplex (BiDi) Fiber

Model	Temp	RJ45 10/100Base- TX Connectors	Fiber Connector	Transmit (dBm)		Receive (dBm)		Power Budget (dB)	Wavelength (nm) TX / RX	Fiber Type	Operating Distance
				Min	Max	Min	Max				
IDS-108F-M1SC2U	Std	8	1 x Simplex SC	-15.0	0.0	-28.0	-8.0	13.0	1310 / 1550	MMF	2 km (1.2 mi)
IDS-108F-M1SC2D	Std	8	1 x Simplex SC	-15.0	0.0	-28.0	-8.0	13.0	1550 / 1310	MMF	2 km (1.2 mi)
IDS-108F-DM1SC2U	Std	8	2 x Simplex SC	-15.0	0.0	-28.0	-8.0	13.0	1310 / 1550	MMF	2 km (1.2 mi)
IDS-108F-DM1SC2D	Std	8	2 x Simplex SC	-15.0	0.0	-28.0	-8.0	13.0	1550 / 1310	MMF	2 km (1.2 mi)
IDS-108F-M1ST2U	Std	8	1 x Simplex ST	-15.0	0.0	-28.0	-8.0	13.0	1310 / 1550	MMF	5 km (3.1 mi)
IDS-108F-M1ST2D	Std	8	1 x Simplex ST	-15.0	0.0	-28.0	-8.0	13.0	1550 / 1310	MMF	5 km (3.1 mi)
IDS-108F-DM1ST2U	Std	8	2 x Simplex ST	-15.0	0.0	-28.0	-8.0	13.0	1310 / 1550	MMF	5 km (3.1 mi)
IDS-108F-DM1ST2D	Std	8	2 x Simplex ST	-15.0	0.0	-28.0	-8.0	13.0	1550 / 1310	MMF	5 km (3.1 mi)

		8 - 10 Port Industrial Ethernet Switch IDS-108F Perle										
IDS-108F-S1ST20U	Std	8	1 x Simplex ST	-14.0	-8.0	-32.0	-3.0	18.0	1310 / 1550	SMF	20 km (12.4 mi)	
IDS-108F-S1ST20D	Std	8	1 x Simplex ST	-14.0	-8.0	-32.0	-3.0	18.0	1550 / 1310	SMF	20 km (12.4 mi)	
IDS-108F-DS1ST20U	Std	8	2 x Simplex ST	-14.0	-8.0	-32.0	-3.0	18.0	1310 / 1550	SMF	20 km (12.4 mi)	
IDS-108F-DS1ST20D	Std	8	2 x Simplex ST	-14.0	-8.0	-32.0	-3.0	18.0	1550 / 1310	SMF	20 km (12.4 mi)	
IDS-108F-S1SC20U	Std	8	1 x Simplex SC	-14.0	-8.0	-32.0	-3.0	18.0	1310 / 1550	SMF	20 km (12.4 mi)	
IDS-108F-S1SC20D	Std	8	1 x Simplex SC	-14.0	-8.0	-32.0	-3.0	18.0	1550 / 1310	SMF	20 km (12.4 mi)	
IDS-108F-S1SC20U-XT	Ind	8	1 x Simplex SC	-14.0	-8.0	-32.0	-3.0	18.0	1310 / 1550	SMF	20 km (12.4 mi)	
IDS-108F-S1SC20D-XT	Ind	8	1 x Simplex SC	-14.0	-8.0	-32.0	-3.0	18.0	1550 / 1310	SMF	20 km (12.4 mi)	
IDS-108F-DS1SC20U	Std	8	2 x Simplex SC	-14.0	-8.0	-32.0	-3.0	18.0	1310 / 1550	SMF	20 km (12.4 mi)	
IDS-108F-DS1SC20D	Std	8	2 x Simplex SC	-14.0	-8.0	-32.0	-3.0	18.0	1550 / 1310	SMF	20 km (12.4 mi)	
IDS-108F-DS1SC20U-XT	Ind	8	2 x Simplex SC	-14.0	-8.0	-32.0	-3.0	18.0	1310 / 1550	SMF	20 km (12.4 mi)	
IDS-108F-DS1SC20D-XT	Ind	8	2 x Simplex SC	-14.0	-8.0	-32.0	-3.0	18.0	1550 / 1310	SMF	20 km (12.4 mi)	
IDS-108F-S1SC40U	Std	8	1 x Simplex SC	-8.0	-3.0	-33.0	-3.0	25.0	1310 / 1550	SMF	40 km (25 mi)	
IDS-108F-S1SC40D	Std	8	1 x Simplex SC	-8.0	-3.0	-33.0	-3.0	25.0	1550 / 1310	SMF	40 km (25 mi)	
IDS-108F-DS1SC40U	Std	8	2 x Simplex SC	-8.0	-3.0	-33.0	-3.0	25.0	1310 / 1550	SMF	40 km (25 mi)	
IDS-108F-DS1SC40D	Std	8	2 x Simplex SC	-8.0	-3.0	-33.0	-3.0	25.0	1550 / 1310	SMF	40 km (25 mi)	

Industrial Ethernet Switch Accessories

Panel Mount kit PM3	Brackets for attaching 30 to 45 mm wide Perle IDS industrial switches inside a control panel or to a wall.
Rack Mount Kit RM4U	Bracket for mounting one or more Perle DIN Rail switches in a standard 19" rack. Occupies "4U" of vertical rack space. 275 mm (10 inches) deep
DIN Rail 24V Power Supply	IDPS-24-40-XT - DIN-Rail 24 VDC , 40Watt power supply with universal 85 to 264 VAC or 120-370 VDC input , -20 to 70°C extended operating temperature. Power Supply Specifications .