

SR-100-XT DIN Rail Media Converters

 perle.com/products/media-converters/sr-100xt-din-rail-copper-fiber-converters.shtml

Industrial Fast Ethernet Copper to Fiber Converters

- 100Base-TX to 100Base-X Fiber Media Converters
- Link copper to multimode or single mode fiber
- Dual fiber ST/SC or Single fiber SC connectors
- Extend network distances up to 40km
- -40°C to +75°C (-40°F to +167°F) extended operating temperature
- Advanced Features: Link Pass-Through, Far-End Fault, Auto-MDIX
- Triple Power Input: Dual Terminal block power connector & T-Bus



Perle **SR-100-XT DIN Rail Media Converters** transparently connect UTP copper to fiber in industrial grade operating temperatures **-40°F to +167°F (-40°C to +75°C)**. Equipment found in **traffic management, oil and gas pipelines, weather tracking, industrial and outdoor applications** must function in temperatures that cannot be supported by a commercial based media converter. These Fast Ethernet Media Converters are ideal for use with industrial devices subjected to harsh environments and severe temperatures such as security cameras, wireless access points, alarms, traffic controllers, sensors and tracking devices.

- Extend the data transmission distance of IP-based devices by connecting their 100Base-TX Copper interface to fiber.
- Extend the distance of an existing industrial network by linking CAT5/6/7 cabling to multimode or single mode fiber.
- Protect Ethernet data from EMI noise and interference by inter-connecting your copper-Ethernet devices over fiber in industrial plants.

An SR-100-XT Media Converter is also available with an SFP slot.

Network Administrators can "see-everything" with Perle's advanced features such as Auto-Negotiation, Auto-MDIX, Link Pass-Through, Far End Fault, and Remote Loopback. This allows for more efficient troubleshooting and less on-site maintenance. These cost and time saving features, along with a lifetime warranty and free worldwide technical support, make **SR-100-XT Fast Ethernet Media Converters** the smart choice for IT professionals.

SR-100-XT Industrial Media Converter Features: 100Base-TX to 100Base-X

Fully designed to operate in extreme temperatures

Perle SR-100-XT Industrial Media Converters only use components that are fully qualified and rated to operate in -40°F to +167°F.

There are other products on the market that claim to operate at -40°F to +167°F however, they use “commercial-grade” components that have not been qualified by the manufacturer (OEM) to operate at the claimed temperature ranges. When “commercial-grade” parts are exposed to extremely high or low temperatures, product failures are inevitable. For example, integrated circuits on the PCB overheat causing premature failures. Under-rated connectors do not allow for proper contact between the device and the cables. These failures eventually stop all data communications in these high and low temperature environments.

By choosing Perle you can be confident you will not be subjected to these failures.

DIN Rail Enclosure

Easily mount on a DIN rail or inside distribution boxes using native DIN Rail enclosure with grounding clip. No need for add-on brackets.

Auto-Negotiation

The media converter supports auto negotiation on the fast ethernet 100Base-TX interface.

Auto-MDIX

Auto-MDIX (automatic medium-dependant interface crossover) detects the signaling on the 100Base-TX interface to determine the type of cable connected (straight-through or crossover) and automatically configures the connection when enabled. With Auto-MDIX enabled, either a straight-through or crossover type cable can be used to connect the media converter to the device on the other end of the cable.

Link Pass-Through

With Link Pass-Through the state of the 100Base-TX receiver is passed to the 100Base-X transmitter to make the media converter appear transparent to the end devices that are connected. In addition, if Far-End Fault is enabled the media converter can turn off the 100Base-TX transmitter when a FAR-End Fault is received.

Using Link Pass-Through with Far-End Fault minimizes data loss when a fault occurs. Should a fault occur, the end devices have the indication of a failure available to them making trouble shooting easier.

Far-End Fault (FEF)

The media converter implements the 802.3 standard for Far-End Fault for the indication and detection of remote fault conditions on the 100Base-X fiber connection. With Far-End Fault enabled the media converter transmits the Far-End Fault Indication over the 100Base-X fiber connection whenever a receive failure is detected on the 100Base-X fiber connection. The media converter continuously monitors the 100Base-X fiber connection for a valid signal.

The action the media converter takes on receiving a Far-End Fault Indication is dependent on the Link Pass Through switch setting.

Duplex

Full and half duplex operation supported.

Pause (IEEE 802.3xy)	Pause signaling is an IEEE feature that temporarily suspends data transmission between two devices in the event that one of the devices becomes overwhelmed. The fast ethernet media converter supports pause negotiation on the 100Base-TX copper connection.
VLAN	The media converter is transparent to VLAN tagged packets.
Remote LoopBack	The media converter is capable of performing a loopback on the fiber port.

Hardware Specifications: SR-100-XT Media Converters

Power

Input Supply Voltage	Triple voltage 12 / 24 / 48 VDC (9.6 – 60 VDC) input supporting: a) 2 x Terminal Block power input and b) 1 x T-Bus power input
Current	0.09 A (@ 24VDC)
Power Consumption	2.6 watts (@ 24VDC)
Power Connector	Dual input Terminal Block and/or T-Bus

Indicators

Power / TST	This green LED is turned on when power is applied to the media converter. Otherwise it is off. The LED will blink fast/slow when in Loopback test mode or hardware error.
Fiber link on / Receive activity (LKF)	On: Fiber link present. Blinking slowly: Fiber link disabled because of copper link loss. Blinking quickly: Fiber link present and receiving data. Off: No fiber link present
Copper link on / Receive activity (LKC)	On: Copper link is present. Blinking quickly: Copper link present and receiving data. Blinking slowly: Copper link disabled because of fiber link loss. Off: No copper link present

Switches - accessible by sliding the chassis open



Auto-Negotiation	<p>Auto (Default - Up): In this mode of operation the media converter will negotiate Ethernet parameters on the copper connection. This will ensure the most optimal connection parameters will be in effect. If the copper link partner does not support Auto negotiation, the media converter will default to 100 Mbps and Half Duplex mode.</p> <p>Off: Auto Negotiation should only be turned off, if the copper link partner does not support Auto Negotiation. When the Auto Negotiation switch is set to the OFF position, the media converter will operate at 100 Mbps and Full Duplex mode.</p>
Smart Link Pass-Through	<p>Smart Link Pass-Through (Default - Up): In this mode, the link state on one connection is directly reflected through the media converter to the other connection. If link is lost on one of the connections, then the other link will be brought down by the media converter. If the installation has a media converter on both ends of the fiber link and both are setup for Link Pass-Through, then a loss of copper link on the far end device will propagate through both media converters and will result in a loss of copper link at the near end device. This would, therefore, resemble a direct copper connection.</p> <p>Standard Mode (Down): In this mode, the links on the fiber and copper sides can be brought up and down independently of each other. A loss of link on either the fiber ports or copper ports can take place without affecting the other connection</p>
Pause	<p>Auto (Default-Up): When Auto Negotiation has been set to Auto, the media converter will use this setting for its Ethernet parameter negotiation on the copper connection.</p> <p>Half: The media converter will not negotiate support for the Pause feature.</p>
Loopback	<p>Disabled (Default-Up): The loopback feature is disabled. This is the normal position for regular operation. The switch must be set to this position for data to pass through the media converter.</p> <p>Enabled: This is a test mode. All data received on the receive (RX) fiber connection is looped back to the transmit (TX) fiber connection. The state of the copper is not relevant and no data or link status is passed through to the copper side.</p>
Far-End Fault (FEF)	<p>Enabled (Default-Up): If the media converter detects a loss of fiber signal on the fiber receiver, it will immediately send a FEF on the fiber link. This notifies the fiber link partner that an error condition exists on the fiber connection. If the remote media converter is set up for FEF, and the local media converter is set up with Link Pass-Through, a loss of fiber link on either the transmit or receive line will be passed through to the local copper connection to notify the connected device. If the media converter has been set to Link Pass-Through mode, the effect will be the same as FEF since the link loss on the fiber receiver will bring down the copper link, which will in turn cause the transmit fiber link to be brought down.</p> <p>Disabled: The media converter will not monitor for or generate Far End Fault.</p>

Cables and Connectors

100Base-TX	RJ45 connector, 2 pair CAT 5 (UTP or STP) or better cable
------------	-----------------------------------------------------------

Fixed Fiber	Dual multimode or single mode (Duplex) fiber - SC, ST Single strand fiber (Simplex) – SC
-------------	-------------------------------------------------------------------------------------------------

Magnetic Isolation	1.5kv
--------------------	-------

Fiber Optic Cable	Multimode: 62.5 / 125, 50/125, 85/125, 100/140 micron Single Mode: 9/125 micron (ITU-T 625)
-------------------	------------------------------------------------------------------------------------------------

Filtering

Filtering	1024 MAC Addresses
-----------	--------------------

Frame Specifications

Buffer	512 Kbits frame buffer memory
--------	-------------------------------

Size	Maximum frame size of 2048 bytes
------	----------------------------------

Packet Transmission Characteristics

Bit Error Rate (BER)	$<10^{-12}$
----------------------	-------------

Environmental Specifications

Operating Temperature	-40 C to 75 C (-40 F to 167 F)
-----------------------	--------------------------------

Storage Temperature	-40 C to 85 C (-40 F to 185 F)
---------------------	--------------------------------

Operating Humidity	5% to 90% non-condensing
--------------------	--------------------------

Storage Humidity	5% to 95% non-condensing
------------------	--------------------------

Operating Altitude	Up to 3,048 meters (10,000 feet)
--------------------	----------------------------------

Heat Output (BTU/HR)	7.37
------------------------	------

MTBF (Hours)	694,621 (Calculation model based on MIL-HDBK-217-FN2 @ 30 °C)
Chassis	Molded plastic DIN Rail case with an IP20 ingress protection rating
Mounting	
Din Rail Kit	Native
Product Weight and Dimensions	
Weight	0.12 kg, 0.26 lbs
Dimensions	114 x 100 x 22.5mm, 4.5 x 3.9 x 0.88 inches
Packaging	
Shipping Weight	0.17 kg, 0.37 lbs
Shipping Dimensions	145 x 105 x 30 mm, 5.7 x 4.1 x 1.2 inches
Regulatory Approvals	
Emissions	FCC 47 Part 15 Class A, EN55032 (CISPR32) Class A EN55011 (CISPR11) ICES-003 EN61000-6-4 (Emissions for industrial environments) CISPR 32:2015/EN 55032:2015 (Class A) CISPR 24:2010/EN 55024:2010 EN61000-3-2
Immunity	EN55024 EN 61000-4-2 (ESD) EN 61000-4-3 (RS) EN 61000-4-4 (EFT) EN 61000-4-5 (Surge) EN 61000-4-6 (CS) EN 61000-4-8 (PFMF) EN 61000-4-11 IEC/EN 61000-6-2 (General Immunity for Industrial Environments)
Electrical Safety	IEC 62368-1(ed 2) EN 62368-1:2014
	CE
Laser Safety	EN 60825-1:2007

Fiber optic transmitters on this device meet Class 1 Laser safety requirements per IEC-60825 FDA/CDRH standards and comply with 21CFR1040.10 and 21CFR1040.11.

Environmental Reach, RoHS and WEEE Compliant

Other ECCN: 5A991

HTSUS Number: 8517.62.0020

Perle Limited Lifetime Warranty

Fast Ethernet to IP Cameras

Connect IP Cameras to Fast Ethernet Backbone

Extend the reach to IP cameras using industrial fiber media converters. Security cameras are typically installed in remote locations where extremely high or low temperatures are a concern -- ceilings, rooftops, light poles, along fences, pipelines and transit routes.

Stand-alone Extended Temperature Media Converters are placed at the remote end connecting cameras with copper interfaces to fiber optic cabling. The fiber can extend the distance up to 40 kilometers using single mode or multimode fiber back to a control center. A media converter chassis located in the data closet at the control center accepts the fiber signal, converts it, and connects to the copper equipment at the main site.

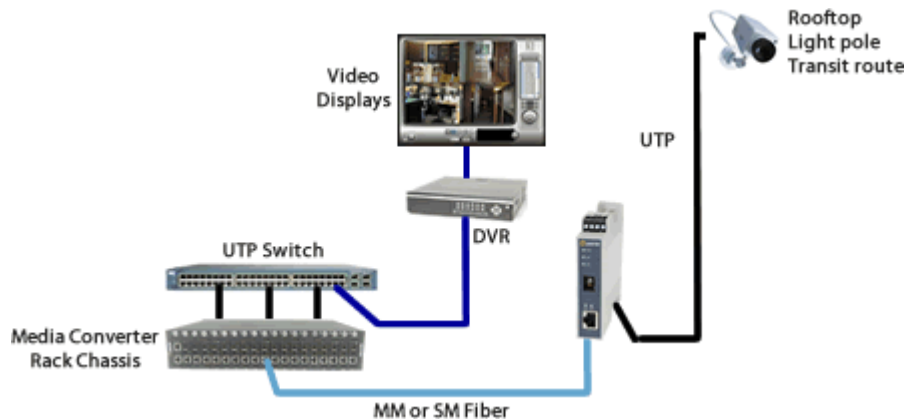

Fast Ethernet Fiber to Wireless Access Points

Connect Wireless Access Points to Fast Ethernet Backbone

Extend the reach to wireless access points (AP) using fiber media converters. When a company deploys a wireless network in their office or large warehouse, APs need to be set up throughout the facility to ensure complete coverage for reliability. The network manager will likely need to extend further than the 100 meters allowed by copper cable to reach many of the APs.

When APs are used in industrial environments where extremely high or low temperatures are a concern, Stand-alone Extended Temperature Media Converters are placed at the remote end connecting APs with copper interfaces to fiber optic cabling. The fiber can extend the distance up to 40 kilometers using single mode or multimode fiber back to a control center. A media converter chassis located in the data closet at the control center accepts the fiber signal, converts it, and connects to the copper equipment at the main site.

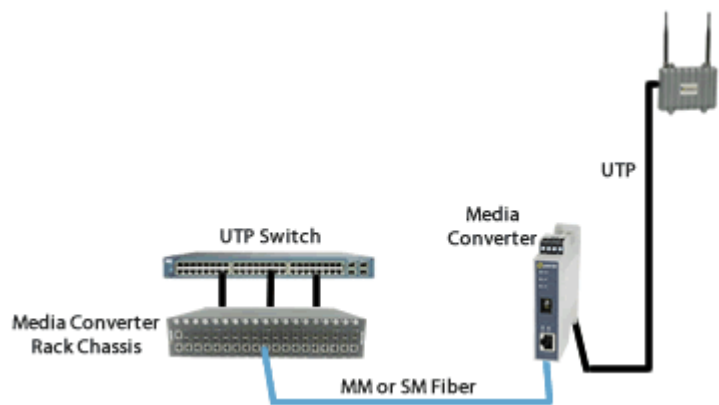

Fast Ethernet UTP Switch to UTP Switch

Extend the network distance between two twisted pair switches

Two Fast Ethernet Media Converters can extend the distance between UTP Switches across a fiber link up to 40km in length.

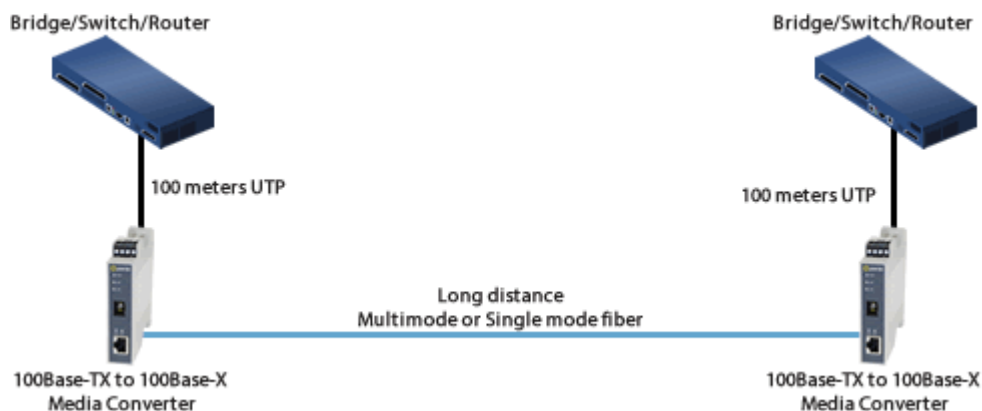

Fast Ethernet UTP Switch to Fiber Switch

Interconnect a UTP Switch with a Fiber Switch

A media converter can interconnect a UTP copper based Switch port to a remote switch that has integrated fiber.

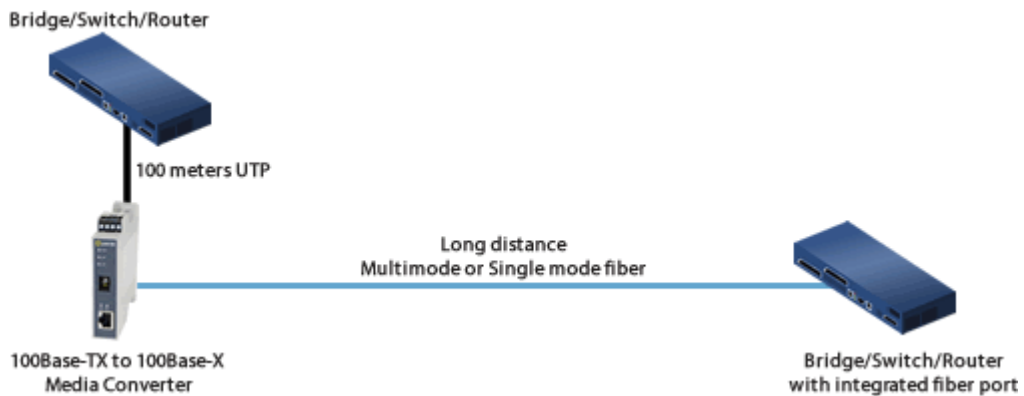

Direct Connect - Long Distance

Direct Connection between two remote devices

With a pair of Fast Ethernet Media Converters two devices, such as file servers, can be connected up to 40km away across a fiber link.

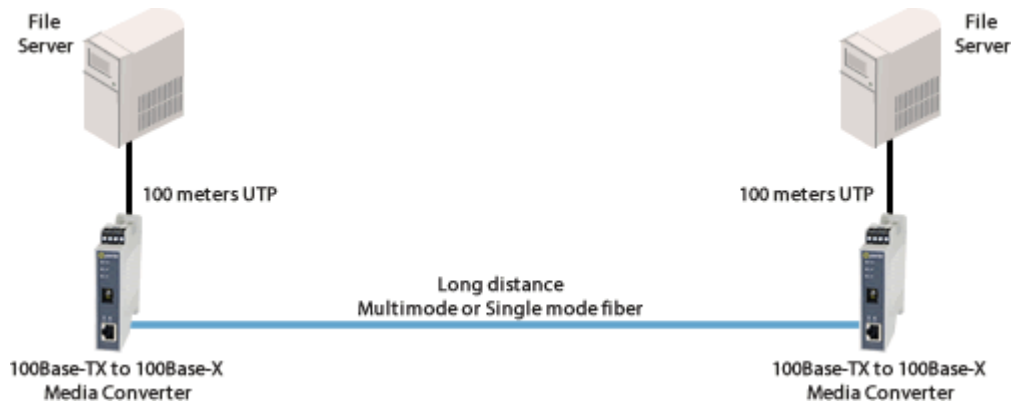

Switch to File Server

Extend the network distance between a Switch and a File Server

Two Ethernet Media Converters can extend the distance between a 100Base-TX Switch and a File Server across a fiber link up to 40Km in length.

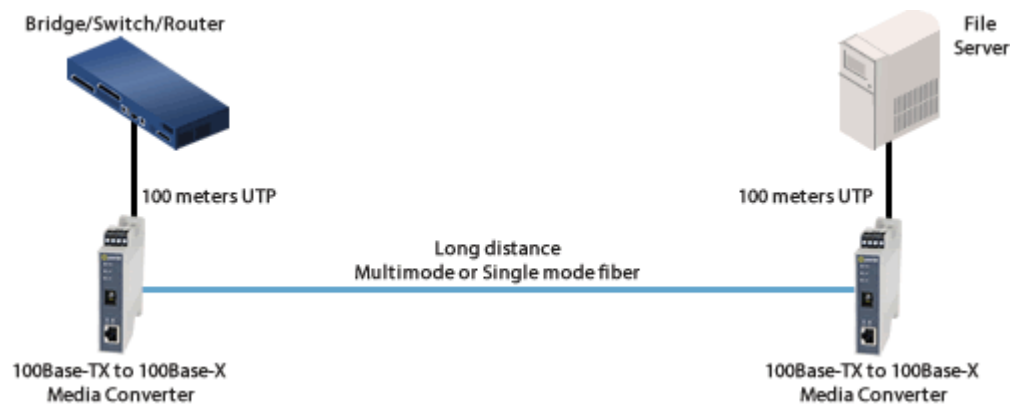

Enterprise Infrastructure

Enterprise Infrastructure using Fiber Optics

Create a fiber infrastructure for your enterprise network without any wholesale replacement of existing copper-based equipment.

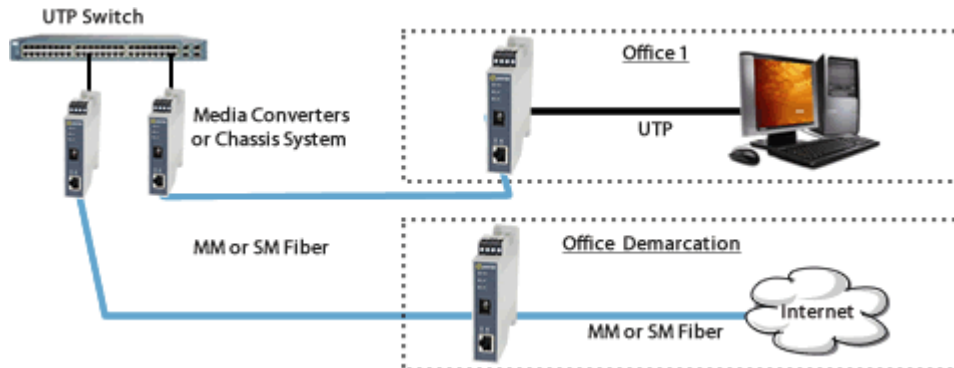

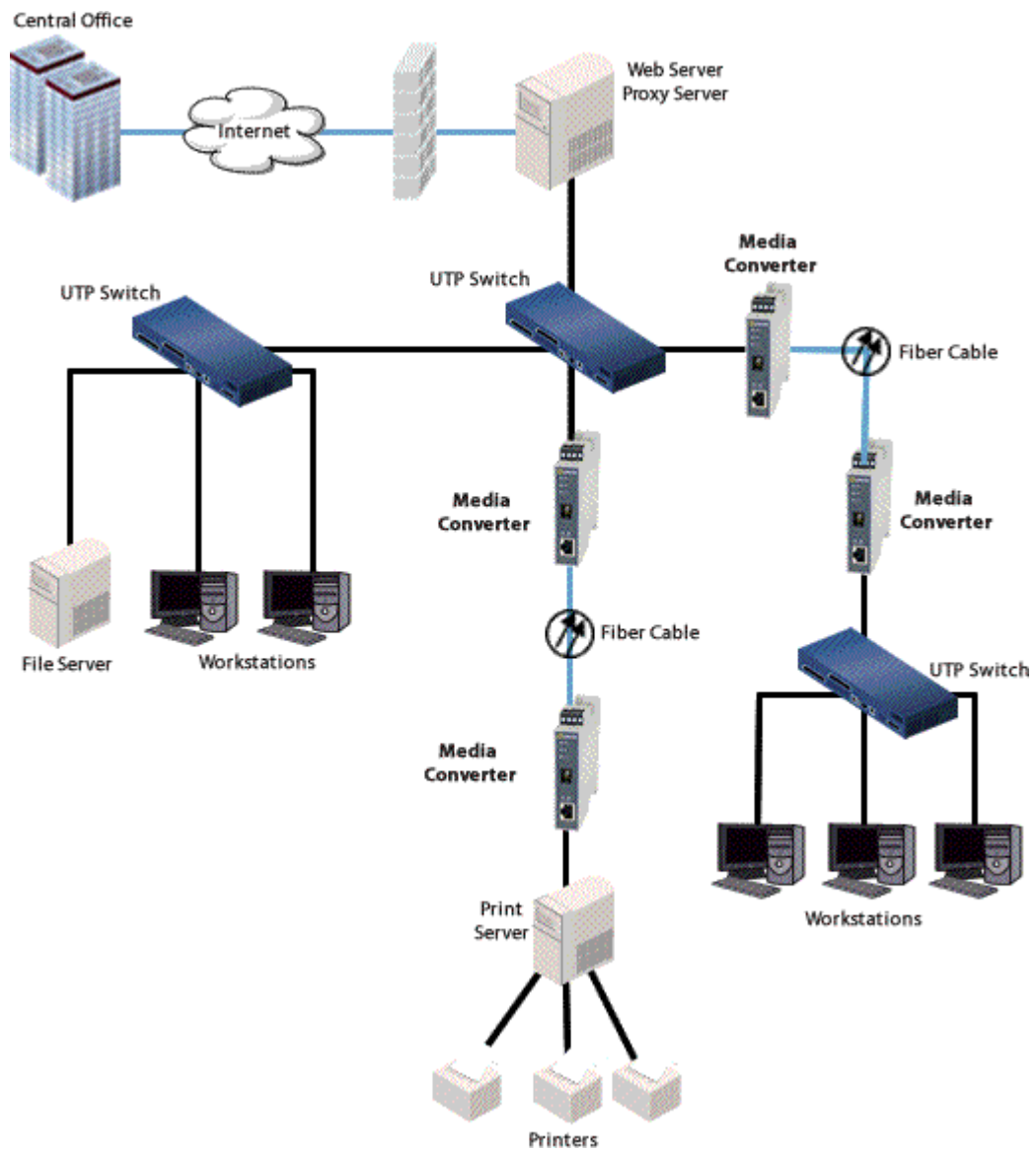

Single Mode / Single Fiber

Connect copper ports over a single fiber strand (also referred to as “Bi-Directional” BiDi)

When Single Strand fiber is used, a pair of Single Fiber Media Converters is needed for the copper to fiber conversion. Perle Single Fiber Media Converters are also referred to as “Up/Down” models. For example the SR-100-SC2U (“Up”) and SR-100-SC2D (“Down”), shown below, must be used in pairs. An “Up” must be matched with a “Down” peer to deal with transmit and receive frequencies separately.

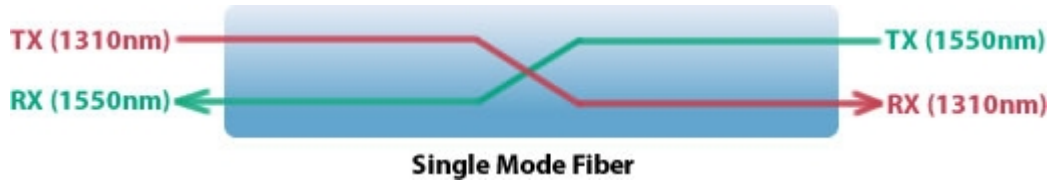

SR-100-SC2USR-100-SC2D

The majority of installations for single mode fiber media converters are of the “dual connector” or “dual fiber” type where one fiber connection is used for transmit, the other for receive. These are physically “crossed” to match up the Transmit/Receive links.

However, to reduce costs, or where there are limits on available fiber, WDM technology may be utilized. WDM uses separate transmit and receive frequencies to communicate on a single fiber strand. WDM technology relies on the fact that optical fibers can carry many wavelengths of light simultaneously without interaction between each wavelength. Thus, a single fiber can carry many separate wavelength signals or channels simultaneously.

So remember, if Single Strand fiber is used, you will need an “Up” Media Converter on one side and a “Down” Media Converter on the other for copper to fiber conversion.

Perle offers a wide variety of Single Fiber (“Up/Down”) Media Converters to connect 10BaseT, Fast Ethernet and Gigabit to single fiber. Whether you need Managed or Unmanaged, Standalone or Modular Chassis Based, 20km or 120km, Perle has the right model to meet your fiber conversion requirement.

Select a Model to obtain a Part Number - SR-100-XT DIN Rail Media Converters

Dual Fiber Models

Model	Connector	Type	Transmit (dBm)		Receive (dBm)		Power Budget (dBm)	Wavelength (nm)	Fiber Type	Operating Distance
			Min	Max	Min	Max				
SR-100-SC2-XT	Dual SC	100Base-FX	-20.0	-12.0	-31.0	-14.0	11.0	1310	MMF	2 km (1.2 mi)



SR-100-ST2-XT	Dual ST	100Base-FX	-20.0	-12.0	-31.0	-14.0	11.0	1310	MMF	2 km (1.2 mi)
SR-100-SC20-XT	Dual SC	100Base-LX	-18.0	-7.0	-32.0	-3.0	14.0	1310	SMF	20 km (12.4 mi)
SR-100-ST20-XT	Dual ST	100Base-LX	-18.0	-7.0	-32.0	-3.0	14.0	1310	SMF	20 km (12.4 mi)
SR-100-SC40-XT	Dual SC	100Base-EX	-5.0	0.0	-34.0	-3.0	29.0	1310	SMF	40 km (25 mi)
SR-100-ST40-XT	Dual ST	100Base-EX	-5.0	0.0	-34.0	-3.0	29.0	1310	SMF	40 km (25 mi)





Single Fiber Models Recommended use in pairs

Model	Connector	Type	Transmit (dBm)		Receive (dBm)		Power Budget (dBm)	Wavelength (nm)	Fiber Type	Operating Distance
			Min	Max	Min	Max				
SR-100-SC20U-XT	Single SC	100Base-BX-U	-14.0	-8.0	-32.0	-3.0	18.0	1310 / 1550	SMF	20 km (12.4 mi)
SR-100-SC20D-XT	Single SC	100Base-BX-D	-14.0	-8.0	-32.0	-3.0	18.0	1550 / 1310	SMF	20 km (12.4 mi)

Part Number **Media Converter Accessories**





29029928	UNO-PS/1AC/24DC/60W DIN-Rail Power Supply: 24 VDC, 60 Watt with universal 85 to 264 VAC, -25 to 70°C extended operating temperature.
29043768	UNO-P/1AC/24DC/150W Power Supply - DIN-Rail 24 VDC , 150 Watt power supply with universal 85 to 264 VAC, -25 to 70°C extended operating temperature
28664918	TRIO-PS/1AC/48DC/5 DIN-Rail Power Supply: 48 VDC, 240 Watt with universal 85 to 264 VAC, 30 to 56V DC output range adjustable, -25 to 70°C extended operating temperature.
28665018	TRIO-PS/1AC/48DC/10 Power Supply - DIN-Rail 48 VDC , 480 Watt power supply with universal 85 to 264 VAC, 30 to 56V DC output range adjustable, -25 to 70°C extended operating temperature
28669838	MINI-SYS-PS-100-240AC/24DC/1.5 Power Supply - For use with modular TBUS DIN rail connector system. 24VDC / 1.5 A, 36 Watts with universal 85 to 264 VAC, -25 °C to 70 °C extended operating temperature
22038528	ME225TBUS15/4P1SBK - TBUS DIN Rail Connector - Transmit power voltage and data across the bus. 4 parallel positions and 1 serial position. UL 8A / cUL 6A, 150 V. Width 22.5cm. Carton of 5. For use with SR and SRS DIN Rail Media Converters.

Product Image	Description	Power Cord	Product Number
	SR-100-SC2-XT - Fast Ethernet Industrial Media Converter: 100Base-TX (RJ-45) [100 m/328 ft] to 100BASE-FX 1310nm multimode (SC) [2 km/1.2 miles], -40F to +167F (-40C to +75C) extended operating temperature support. DIN Rail case, terminal block (Combicon) power connector for external power source	None	05091200
	SR-100-ST2-XT - Fast Ethernet Industrial Media Converter: 100Base-TX (RJ-45) [100 m/328 ft] to 100BASE-FX 1310nm multimode (ST) [2 km/1.2 miles], -40F to +167F (-40C to +75C) extended operating temperature support. DIN Rail case, terminal block (Combicon) power connector for external power source	None	05091210
	SR-100-SC20-XT - Fast Ethernet Industrial Media Converter: 100Base-TX (RJ-45) [100 m/328 ft] to 100Base-LX 1310nm single mode (SC) [20 km/12.4 miles], -40F to +167F (-40C to +75C) extended operating temperature support. DIN Rail case, terminal block (Combicon) power connector for external power source	None	05091220

Product Image	Description	Power Cord	Product Number
	SR-100-ST20-XT - Fast Ethernet Industrial Media Converter: 100Base-TX (RJ-45) [100 m/328 ft] to 100Base-LX 1310nm single mode (ST) [20 km/12.4 miles], -40F to +167F (-40C to +75C) extended operating temperature support. DIN Rail case, terminal block (Combicon) power connector for external power source	None	05091230
	SR-100-SC40-XT - Fast Ethernet Industrial Media Converter: 100Base-TX (RJ-45) [100 m/328 ft] to 100Base-LX 1310nm single mode (SC) [40 km/24.9 miles], -40F to +167F (-40C to +75C) extended operating temperature support. DIN Rail case, terminal block (Combicon) power connector for external power source	None	05091240
	SR-100-ST40-XT - Fast Ethernet Industrial Media Converter: 100Base-TX (RJ-45) [100 m/328 ft] to 100Base-LX 1310nm single mode (ST) [40 km/24.9 miles], -40F to +167F (-40C to +75C) extended operating temperature support. DIN Rail case, terminal block (Combicon) power connector for external power source	None	05091250
	SR-100-SC20U-XT - Fast Ethernet Industrial Media Converter: 100Base-TX (RJ-45) [100 m/328 ft] to 100Base-BX 1310nm TX / 1550nm RX single strand fiber, single mode (SC) [20 km/12.4 miles], -40F to +167F (-40C to +75C) extended operating temperature support. DIN Rail case, terminal block (Combicon) power connector for external power source	None	05091260
	SR-100-SC20D-XT - Fast Ethernet Industrial Media Converter: 100Base-TX (RJ-45) [100 m/328 ft] to 100Base-BX 1550nm TX / 1310nm RX single strand fiber, single mode (SC) [20 km/12.4 miles], -40F to +167F (-40C to +75C) extended operating temperature support. DIN Rail case, terminal block (Combicon) power connector for external power source	None	05091270

Accessories

Accessory Image	Description	Model Number	Accessory Number
-----------------	-------------	--------------	------------------

Accessory Image	Description	Model Number	Accessory Number
Power Supply			
	<p>TRIO-PS/1AC/48DC/5 DIN-Rail Power Supply: 48 VDC, 240 Watt with universal 85 to 264 VAC, 30 to 56V DC output range adjustable, -25 to 70°C extended operating temperature.</p>	<p>TRIO-PS/1AC/48DC/5 Power Supply</p>	<p>28664918</p>
	<p>TRIO-PS/1AC/48DC/10 Power Supply - DIN-Rail 48 VDC , 480 Watt power supply with universal 85 to 264 VAC, 30 to 56V DC output range adjustable, -25 to 70°C extended operating temperature</p>	<p>TRIO-PS/1AC/48DC/10 Power Supply</p>	<p>28665018</p>
	<p>MINI-SYS-PS-100-240AC/24DC/1.5 Power Supply - For use with modular TBUS DIN rail connector system. 24VDC / 1.5 A, 36 Watts with universal 85 to 264 VAC, -25 °C to 70 °C extended operating temperature</p>	<p>MINI-SYS-PS-100-240AC/24DC/1.5 Power Supply</p>	<p>28669838</p>
	<p>UNO-PS/1AC/24DC/60W DIN-Rail Power Supply: 24 VDC, 60 Watt with universal 85 to 264 VAC, -25 to 70°C extended operating temperature.</p>	<p>UNO-PS/1AC/24DC/60W Power Supply</p>	<p>29029928</p>
	<p>UNO-PS/1AC/24DC/150W Power Supply - DIN-Rail 24 VDC , 150 Watt power supply with universal 85 to 264 VAC, -25 to 70°C extended operating temperature</p>	<p>UNO-PS/1AC/24DC/150W Power Supply</p>	<p>29043768</p>

Copyright © 1996 - 2022 Perle. All Rights Reserved