



**QNAP**



Use your Turbo vNAS as a PC

# TS-ECx80U R2 Series

## 8/12/16/24 - Bay Turbo NAS



TS-EC880U R2



TS-EC1280U R2



TS-EC1680U R2



TS-EC2480U R2



Built-in Dual-port 10GbE SFP+ Network Adapter



40GbE ready

- Based on tiered storage architecture with SSD cache acceleration
- Virtualization Station and Container Station Provide the new era of the virtual computing
- Unified storage management support iSCSI ( File or Block based ) , NFS and Samba
- Scale up storage with QNAP REXP-1220U-RP / REXP-1620U-RP expansion units, daisy chaining up to 8 units for total 1024TB raw capacity
- Support ECC & Non ECC RAM

# Overview

In the era of big data, there is a wealth of data generated and exchanged by the billion of devices on the Internet of Everything (IoE) and across hybrid cloud devices. The rampant data growth requires increasingly flexible storage solutions that will ensure business continuity. QNAP has strived to provide enterprises and SMBs with the facilities and tools to attain storage services to meet the ever-growing capacity demand and results in reduced overall operation risks and costs.

Besides managing data growth, another major challenge for an organization is its ability to keep existing data available and protected in the event of a disaster or system failure. QNAP's flexible storage solutions incorporate features such as tiered storage, snapshots, thin provisioning, and LUN backup to better match specific business requirements and cope with disastrous situations.

QNAP NAS has demonstrated its ability to offer a complete product portfolio that fits for every SMB and small to medium enterprise, including a wide range of hard disk models and iSCSI SAN solutions.



# Table of Contents

P. 01	Unified Storage management and data protection
P. 04	Qtier™ Technology
P. 07	Snapshot
P. 11	File Station 4.2, Management and Sharing
P. 15	Hybrid Backup Solutions
P. 20	QPulse™ Remote Management System
P. 22	Q'center CMS (Central Management System)
P. 24	Virtualization Station 2.0
P. 28	Container Station 1.0
P. 32	QvPC Technology
P. 35	Virtualization Applications
P. 38	QNAP NAS is DataCore Ready
P. 39	Productivity Tools
P. 40	myQNAPcloud 2.0
P. 43	Qsync Central Center 2.0
P. 45	Notes Station 2.1
P. 47	Qsirch 2.1
P. 49	Surveillance Station 5.1
P. 54	App Center
P. 61	Mobile Apps & Utilities
P. 67	Computer Utilities
P. 69	Hardware Introduction
P. 70	Built-in 10GbE and 40GbE Ready
P. 71	10GbE/40GbE Application
P. 72	QNAP 12Gbps SAS JBOD Expansion Enclosure
P. 74	Hardware specification
P. 75	JBOD Hardware / Accessory / Network card compatibility list
P. 76	Software specification

# Unified Storage management and data protection

A converged management platform combining cloud and tiered storage technology

In addition to existing storage management and backup functions, the new Snapshot and Backup Versioning help you improve data security while lowering storage expenses. By integrating public cloud storage and backup services, your QNAP NAS is a converged storage management platform offering on-premise, private, offsite, and cloud services.

## Intelligent Storage Manager - Unified storage management

The QTS Storage Manager neatly presents tools and options for managing system storage with an intuitive graphical interface. From reviewing the system storage allocation in the Dashboard, to managing volumes, Storage Pools, disks and iSCSI storage, or even the new Snapshot function, the Storage Manager provides a centralized place to simplify hard drive management and to maximize storage usage.

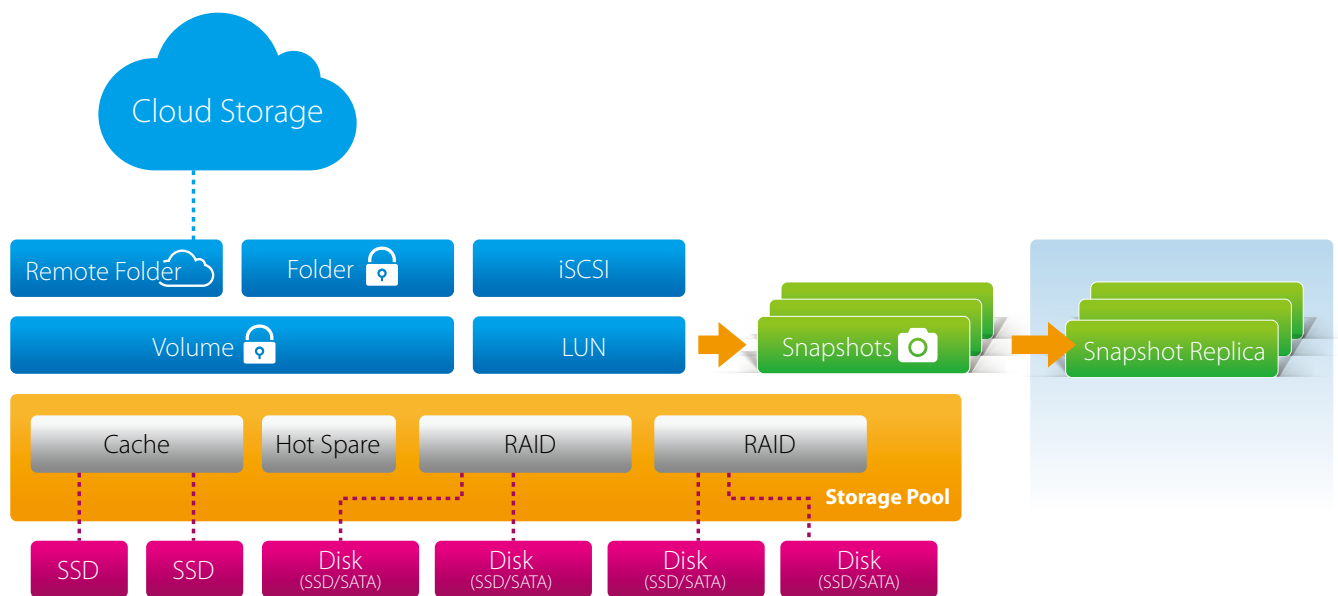

## Dashboard

The Storage Manager dashboard provides an overview for IT administrators to easily monitor and manage storage allocations. QTS 4.2 provides a more secure and flexible way to store and manage data stored on your NAS. This next generation volume offers powerful features such as storage pooling with multiple RAID groups, thin-provisioned volumes with space reclamation, and online capacity expansion.



In addition to Storage Manager, IT administrators can also check volume status of shared folders with File Station.



## Storage management

IT administrators can monitor HDD allocation status for RAID groups in addition to individual HDD information. This ensures that there are no idle HDDs, maximizing utilization of the storage resources. IT administrators can aggregate multiple RAID groups into a single storage pool to flexibly utilize the storage capacity as a whole and protect them using redundancy, allowing for better protection against multiple disk failures for large-capacity environments. Multiple volumes can now be created on the Storage Pool to provide flexible deployment.

## Volume

QTS 4.2 supports the creation of multiple volumes within a Storage Pool. View all available storage pools, volumes, and iSCSI LUNs on the same screen including comprised RAID groups. This enables the expansion or removal of current pools and volumes, set threshold values for capacity consumption alerts, and RAID group management. Data volumes and LUNs can be extended without interrupting services.

- **Thin provisioning**

Over-allocation enables a server to view more storage capacity than has been allocated in a storage pool. Further, the physical storage capacity is used only when files are written by the application, improving utilization rates.

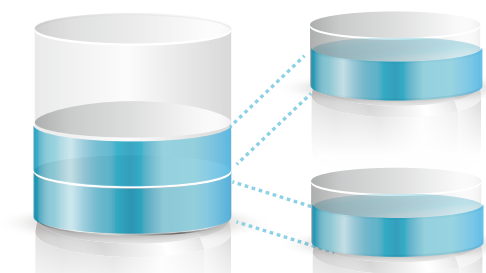

Efficiently use storage spaces with incremental allocation.

- **Thick provisioning**

Physical storage capacity is dedicated during the initial allocation of the storage volume.

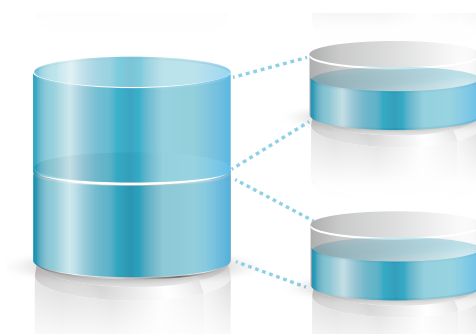

Allocate all spaces specified and they cannot be used by other volumes or LUNs.

## ➤ iSCSI (Block based LUN)

QTS 4.2 supports two types of LUNs for efficient storage utilization: block-level and file-level iSCSI LUNs. The Turbo vNAS also supports multiple types of configurations for server connections:

- ◆ single LUN or multiple LUNs per iSCSI target.
- ◆ multiple iSCSI targets for a single LUN, only used for clustered environments

- **Block-Level iSCSI LUN**

Deploy block-level iSCSI LUN as volumes to reduce overhead and improve overall read/write performance.

- **File-Level iSCSI LUN**

File-level iSCSI LUNs can be used to create a disk image for an iSCSI LUN where storage space is a premium.



Both block-level and file-level iSCSI LUNs support thin provisioning, space reclamation, and online capacity expansion. We recommend using block-level iSCSI LUNs unless there is a limitation on space usage.

## Virtual Disk Drives increase storage expansion flexibility

Virtual disks provide a flexible way for IT administrators to expand storage. By using the built-in iSCSI initiator to connect an iSCSI target of the Turbo NAS, you can create a virtual disk on the local server. The Turbo NAS can act as a stack master to connect up to 8 virtual disks or stack targets, aggregating storage space from multiple NAS systems. NAS users then only need to connect to a single target to access the space from all of the network storage devices.

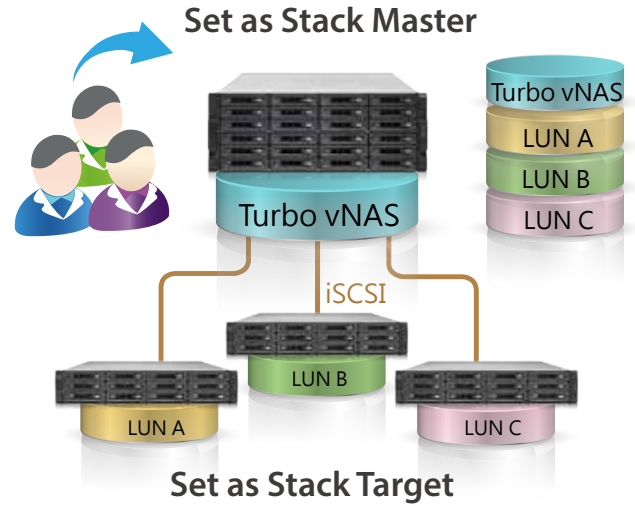

## CIFS (SAMBA)

Server Message Block (SMB), a version of which is known as Command Internet File System (CIFS), is the default file-sharing service on QNAP NAS. It is mainly used for sharing files among systems using this protocol, such as Windows and Unix-like systems and can also be used as a primary domain controller (PDC).

## NFS

QTS 4.2 supports Network File System (NFS), which allows a server to share directories and files with clients over a network. With NFS, client computers can mount file systems over a network. Users can access shared files on these file systems as though they are mounted locally.

## QNAP high-performance unified and tiered storage solutions

Data used by enterprises continues to grow exponentially and with greater diversity in data types and importance. It is imperative to offer a secure and efficient storage solution that can process this enormous amount of data while minimizing the total cost of ownership.

Establishing a tiered storage system based on efficiency and capacity can aid in improving overall processing efficiency.

Enterprises can classify data accordingly by sharing folders with a file-based storage system and processing files that require more demanding data throughput with a block-based storage system to accommodate different usage models.

QNAP Turbo vNAS business series can flexibly configure different tiers to hard drives on a single unit according to different data usage needs, delivering the best unified and tiered storage solution.

## Tiered storage architecture optimizes storage efficiency

Nowadays, business needs for big data storage keeps increasing. It is crucial that businesses can utilize cost-efficient storage solutions featuring tiered architecture to tackle Hot Data (frequently-used data) and Cold Data (less-used data) applications with the flexible configuration of storage devices to boost storage efficiency.

In order to achieve the goal of tiered storage, the TS-ECx80U R2 series supports to connect to multiple SAS 12 Gbps expansion enclosures. The SAS 12 Gbps expansion enclosures can be installed with 15K SAS hard drives or NL-SAS/SATA hard drive.

As different storage devices vary in features, businesses have to thoroughly assess their storage needs in performance and capacity to choose the right business hard drives for maximum cost efficiency. The following illustration shows the tiered storage architecture.

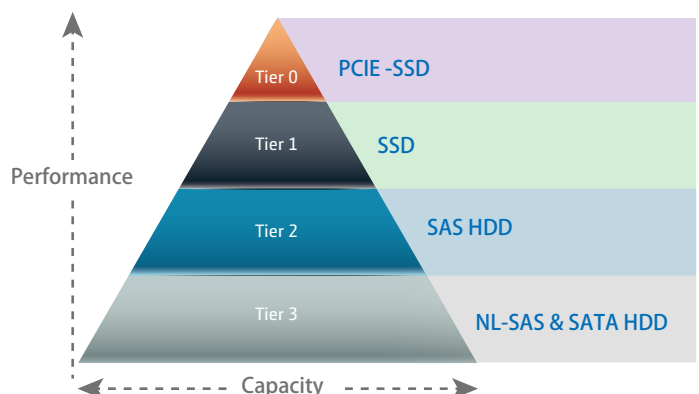



# Qtier™ Technology

Exceptional performance in balancing hot & cold data in large storage environments

An intelligent auto-tiering solution that provides high flexibility in large storage environments by recognizing hot and cold data while also providing the lowest TCO per gigabyte cost, superior system performance and management efficiency.

QNAP's auto-tiering technology, Qtier™, is a multi-tier storage management system. Qtier™ automatically moves the most active data to the high-performance drives while less active data is migrated to high-capacity drives. This alleviates the burden on administrators by supporting tasks of performance pre-estimation, layout design, and relocation of data according to performance and budgets.

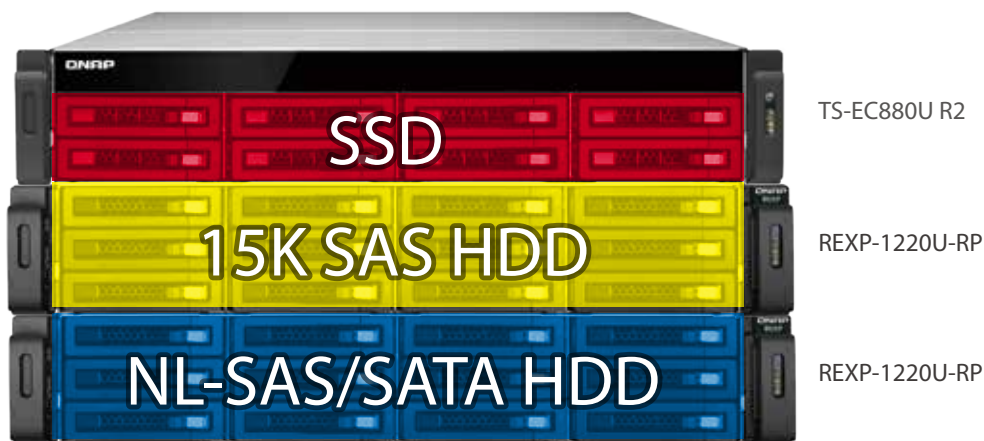

After installing a SAS 12Gbps HBA in a TS-ECx80U R2 SATA series model, and then connecting 12Gbps SAS REXP-x20U-RP expansion units to the NAS; high-performance SAS 6Gbps/12Gbps SAS HDDs can be used in the system and they will be classified as Tier 2 storage (High Speed) within Qtier™ (QNAP's auto-tiering technology).

Please enable Auto-tiering when creating a Storage Pool.

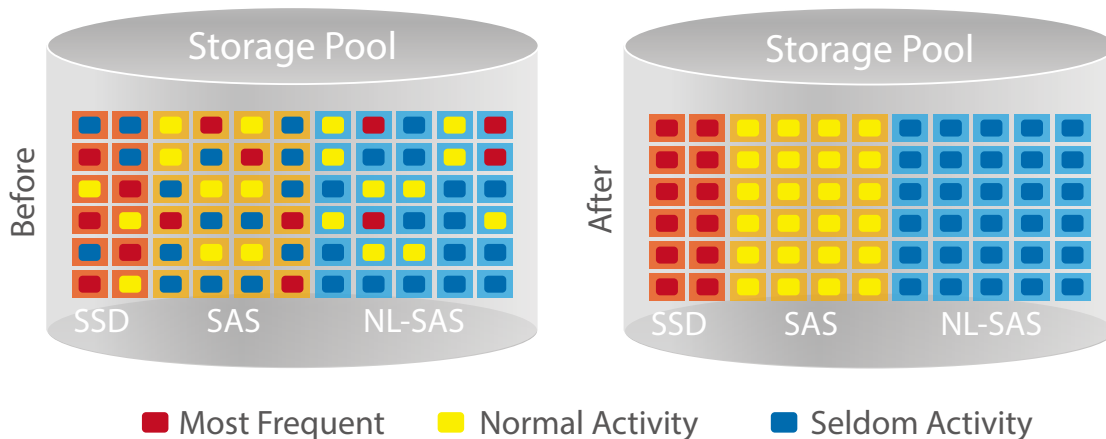

## QNAP Auto-tiering architecture

- Data migration based on Transaction-based B-tree Update

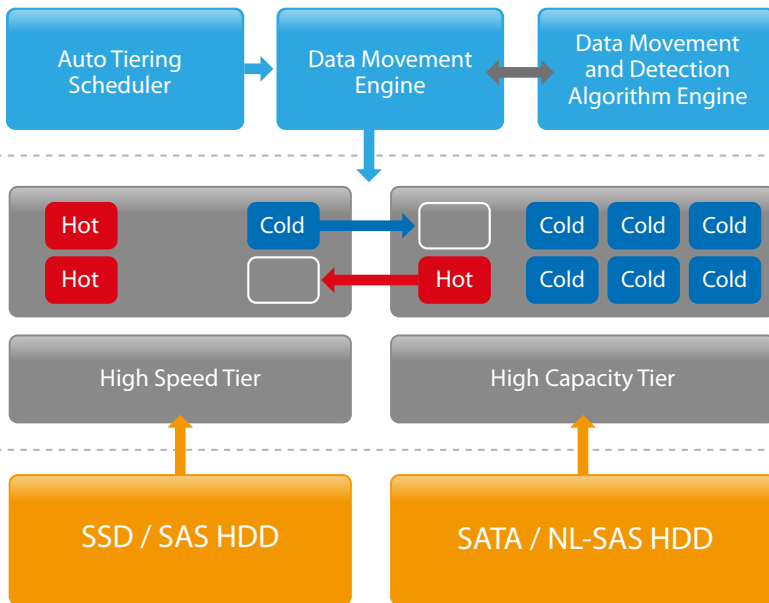

Based on the results of B-tree calculation, the NAS will automatically move data blocks with higher weights to higher tier (e.g. moving data blocks from HDD RAID Group to SSD RAID Group). Here data migration and metadata update will not interfere with normal IO; therefore, transaction-based B-tree update will avoid problems with data integrity.

You can get the statistics of all data waiting to be processed as well as finishing processed in this phase. If the administrators need to do administrative tasks or there are bandwidth requirements for external connections, they can stop data migration in this phase. Furthermore, assigning weights can help adjust bandwidth allocation or alleviate congestion between external IO and internal data migration.

The goal of the auto-tiering function on the QNAP NAS is to optimize the use of the storage infrastructure by simultaneously improving storage utilization and performance:

- ♦ Move frequently used data onto fast disks for high-availability or high I/O cache throughput
- ♦ Move less frequently used data onto low-cost, high-capacity disks for better cost efficiency

To achieve the required level of performance and cost benefits, data is categorized based on access frequency. Service levels such as response times or runtime must be measured and evaluated in advance to decide which data must be stored at a given time in a certain tier.

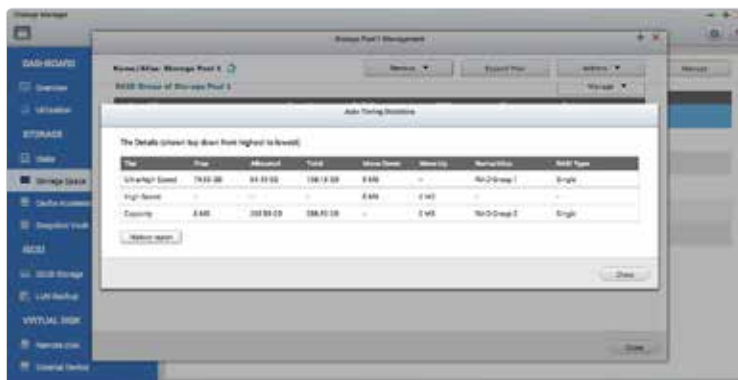
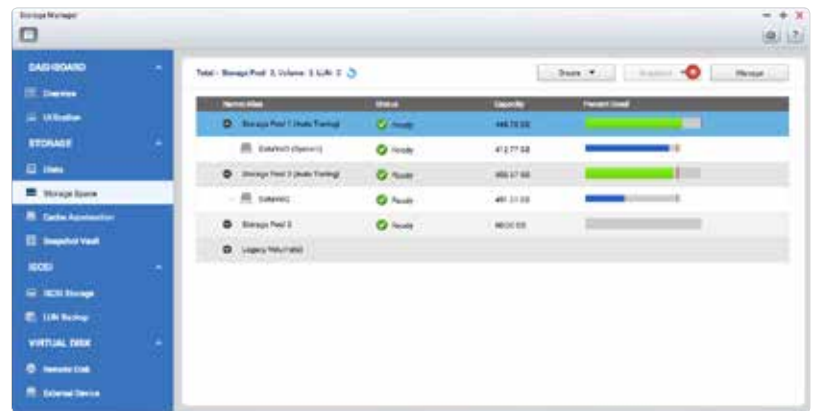

### 3 levels of tiered storage

Qtier™ offers a 3-tier configuration, namely, ultra-high speed (SSD), high speed (SAS) and high capacity (SATA/NL-SAS) for a combination of different disk drives:

- ♦ Tier 1 (Ultra-high Speed): SSD drives
- ♦ Tier 2 (High Speed): SAS drives
- ♦ Tier 3 (Capacity): SATA or NL-SAS drives



## Detailed and visualized statistics for performance analysis

Historical data assists users in performance tuning and storage provisioning, enabling accurate adjustment of auto-tiering policies.

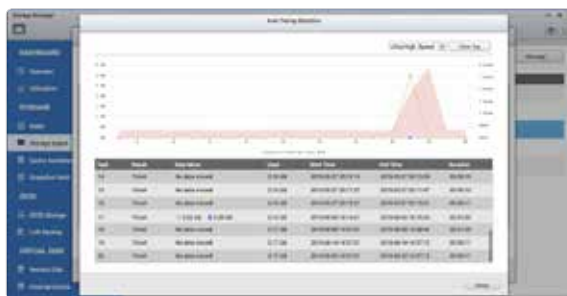

## User-defined policies for better auto-tiering efficiency

Policy defined auto-tiering enables dynamic reallocation of data corresponding to the performance requirements of the data or applications in addition to scheduling and prioritization of data migration.

The following is a comprehensive comparison of storage technologies:

	Qtier™	Full SSD	SSD Cache
Costs	\$	\$\$	\$
Storage space	Big	Small	Big
Available SSD space	Extends as needed	Extends as needed	Limited by available memory
Data migration method	Scheduled	No	Automatic
Data migration mechanism	Moves data according to access frequency	All data is in SSD storage	Replicates frequently accessed data to SSD storage
Application scenarios	Typically used for predictable I/O workloads such as file/web/e-mail servers and application virtualization or video editing	Typically used for applications requiring fast/intensive I/O such as databases or virtualized environments	Typically used in a highly frequent data access environment such as virtualized applications or high-resolution video or audio processing

## Qtier™ with SSD Cache for around-the-clock acceleration

Qtier™ fully supports concurrent tiering and SSD caching. In this mode, Qtier™ constantly monitors I/O activity and keeps active data that requires small, mostly random, read and write operations in SSD Read-only or Read-write cache and other data in the tiered storage automatically moving data between the appropriate tiers. QNAP unified and tiered storage is an intelligent, automated storage system for managing data placement to help optimize performance and cost requirements in multi-tier configurations.

Qtier™ Technology is a convenient, economical and insightful way to store and balance your active (hot) and archived (cold) data. The intelligent Auto-tiering feature allows you to have your frequently-accessed data on high-speed SSD in the NAS for quick access and high performance. At the same time, you still have access to your archived and seldom-used data on the NAS's SAS and SATA drives. This provides the versatility of extreme performance, a large storage capacity and a lower cost per gigabyte to store and balance your data.

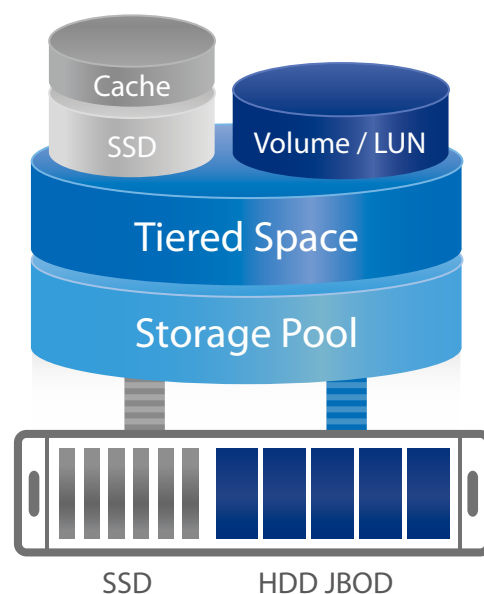



# Snapshot

Block – Level Local Snapshot and Snapshot Replica —An Efficient and economical way to protect files

QNAP’s Whole Volume/LUN Snapshot Agent records the status of files using the Copy on Write mechanism. This helps in recovering files to a previously saved state in case of accidental deletion or modification and meeting enterprise requirements of improving Recovery Point Objective (RPO) and Recovery Time Objective (RTO).

## Benefits of QNAP Snapshot

The block-based QNAP snapshot technology can assist in saving space and reserve snapshots for future use as different from traditional backup, block-level snapshot technology will only backup the modified part of a file. QNAP Snapshot supports up to 256 snapshots for each volume or LUN, up to 1024 snapshots for the whole system.

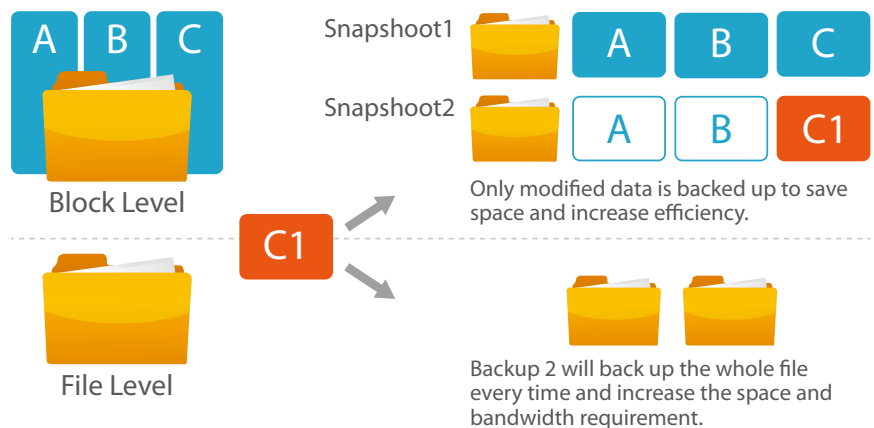

Only modified data is backed up to save space and increase efficiency. Whole data backup (higher space requirement and reduced efficiency).

	Snapshot Replica	RTRR	Rsync	NAS to NAS
Data Format	Volume / LUN	Shared Folder	Shared Folder	Shared Folder
Backup Format	Block-based	File-level file-based	File-level block-based	File-Level block-based
Modified File Handling	Only back up modified file	Re back up whole file	Compare source and destination files and transmit only changed data blocks	
Time	Scheduled	Real time/ Scheduled	Scheduled	Scheduled
Encryption	Supported	Supported	Supported	Supported
Compression	Supported	Supported	Supported	Supported
Memory Requirement	4GB RAM Required	No Requirement	No Requirement	No Requirement
Remote System	QNAP NAS	QNAP NAS	Rsync Server	QNAP NAS
Using Scenario	<ul style="list-style-type: none"> <li>Lot of small data</li> <li>Large file that need continues modification (VM image or backup image)</li> </ul>	<ul style="list-style-type: none"> <li>Real time replication or synchronization</li> <li>Fast transmit within local LAN</li> </ul>	<ul style="list-style-type: none"> <li>Large file that need continues modification</li> <li>Transmit in long distance</li> </ul>	

## Local Snapshot to provide continuous data protection

- File-level recovery

The low-impact, small-sized, and user recoverable snapshots offer more benefits of storage administration compared to traditional file copies, which are often stored as a single large data file. For instance, you can choose to recover a file in a folder or the entire folder instantly with a few clicks.

• High Flexibility

Snapshots can be used with iSCSI LUNs and Volumes in QNAP NAS and Expansion Units to achieve full protection. On the other hand, Snapshot Replica allows you to transfer your snapshot to a remote QNAP NAS for backup.

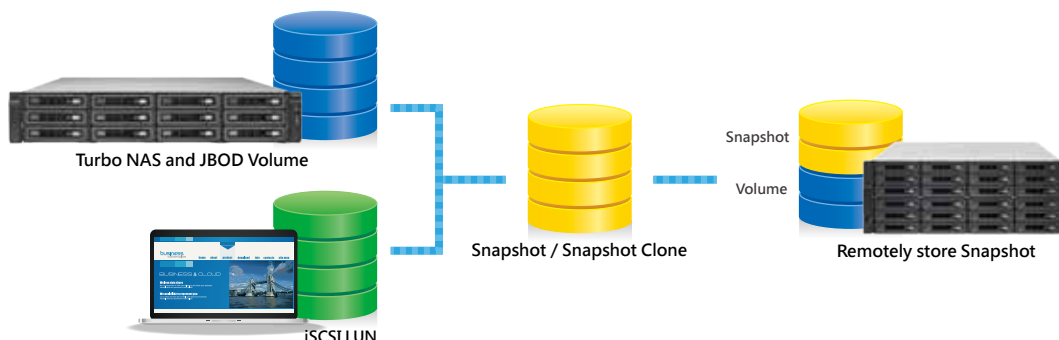

• Data visibility

The QNAP Snapshot provides tools in Storage Manager to help you find specific files to recover. You can easily view files and folders in a snapshot and browse through different snapshots displayed in chronological order. In addition, file recovery just takes a few clicks, increasing operational efficiency.



• The files in a snapshot clone can be freely edited by users.

Clone a snapshot as a volume or LUN for quick file access, eliminating long restore times and reserving sizeable space for storing backups. The files in a snapshot clone can be freely edited by users.

• Rsync/RTRR integration

The Rsync/RTRR functions in Backup Station automatically detect whether the system supports Snapshots. The RTRR/Rsync functions take snapshots of the volume before starting replication and then back up snapshots to a remote server. This greatly enhances data integrity.

• Windows Previous Versions Supports

Snapshots enables Windows users to restore files directly using the Windows previous versions feature in Windows explorer, to save time and effort without requiring IT administrators' support.



• Remote Snapshot Replica prevents data loss

Snapshot Replica

The Remote Snapshot Replica enables you to replicate volume/LUNs between different remote servers using snapshot technology, which helps to reduce storage consumption and bandwidth. Either take the snapshot immediately or set up a snapshot schedule. It is considered one of the most comprehensive strategies for data backup.



## Snapshot Vault

Snapshot Vault is the backup center for storing and managing every snapshot created remotely from another QNAP NAS. It is also capable of cloning a snapshot (with specified files in a snapshot) as a local volume for data access. comprehensive strategies for data backup.

### NAS- to-NAS Snapshot Replica

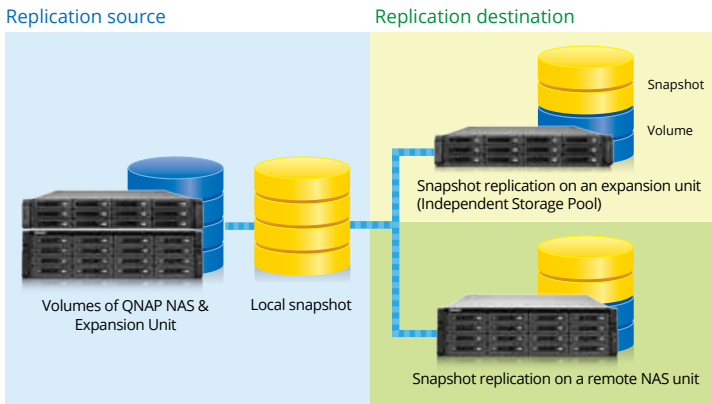

### One-to-Many & Many-to-One Snapshot Replication

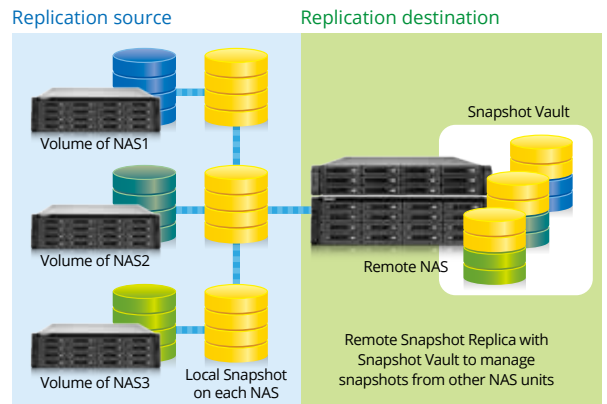

- Managing snapshots remotely from another NAS

Use the Clone function to clone (or mount) a snapshot from the Snapshot Vault as a volume or iSCSI LUN on a QNAP NAS. Directly access these files through File Station or Backup Station. Use an iSCSI initiator to connect to a cloned iSCSI LUN from another computer.

- Replication Settings

To minimize the risk of data breach, the Snapshot Replica provides the option of file encryption. It also provides file compression and transfer rate adjustment to lower bandwidth consumption.

- Application Consistent Snapshots with Snapshot Agent

Snapshot Agent, used for iSCSI LUN, allows connecting the Turbo NAS with the remote servers (VMware vCenter or Windows Server) to ensure consistent snapshots. On those remote servers, the running applications (VMware virtual machines, Hyper-V virtual machines, SQL server, Windows file server...) will write/flush the data from the memory to the iSCSI LUN prior the snapshot is taken. The application will then be consistent and include all necessary data. In case of snapshot restoration, no data will be missing.

Snapshot Agent also includes VSS Hardware Provider for Windows to allow taking snapshot on the NAS from the backup software use on Windows server. The Snapshot process can be offloaded to the NAS and reduce the loading on the server.

### VSS Hardware Provider Work Flow

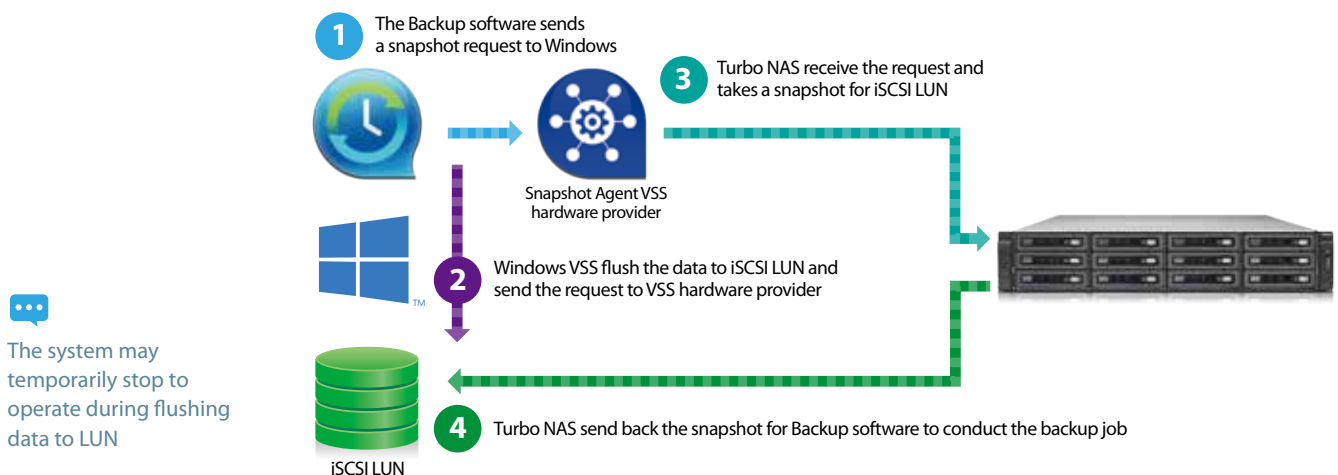



## Snapshot Agent Work Flow

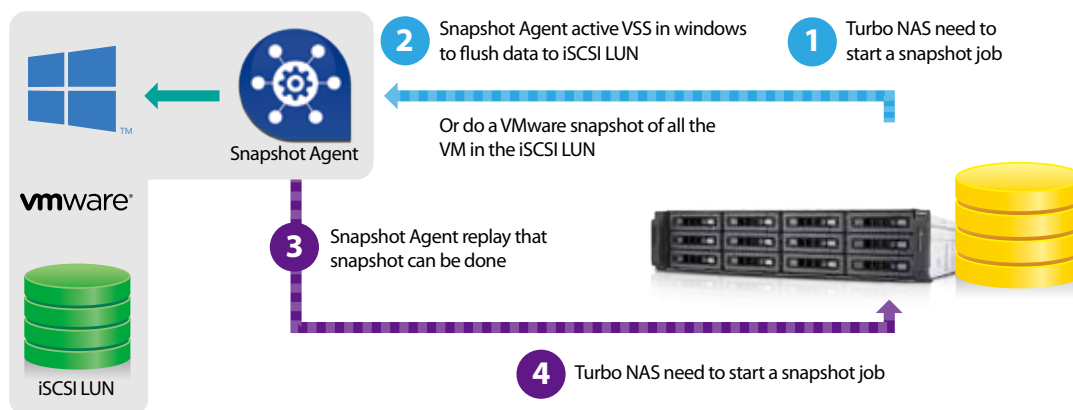

⋮ The system may temporarily stop to operate during flushing data to LUN

## QNAP and Acronis True Image® BackupSolution

QTS is compatible with various renowned backup software including Acronis® True Image™, Symantec® Backup Exec, and many others. Backup entire disk drives, documents, pictures, music, videos, fonts, emails, and more – to one or multiple NAS units. With a very simple setup process, you can set up real-time backups and fully automated scheduled backups. Mac users can also use Time Machine® to back up files from Mac workstations.

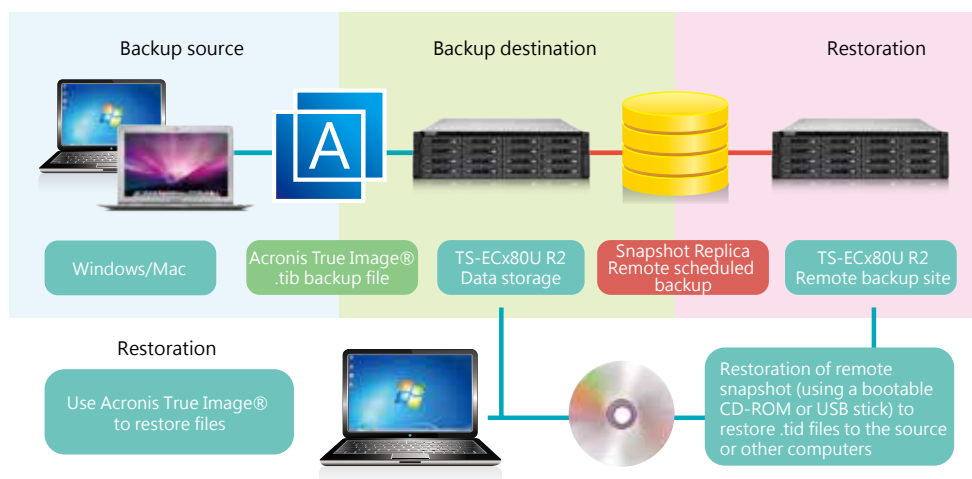

⋮ The Acronis True Image® Logo and related material are belong Acronis International GmbH, for more information please check <http://www.acronis.com/en-us/personal/computer-backup/>

## • QNAP Snapshot Replica with Industry 4.0 Using Scenario

In production site, business now look into the concept of industry 4.0 and continue to allow manufacturing process become more intelligent and automatic, while data analysis must be in real time to maximum it's benefit, you can setup a Warm Database for analysis using TS-ECx80U R2 series and Snapshot Replica, allowing near real time data analysis while reducing the loading on the production site's data center.

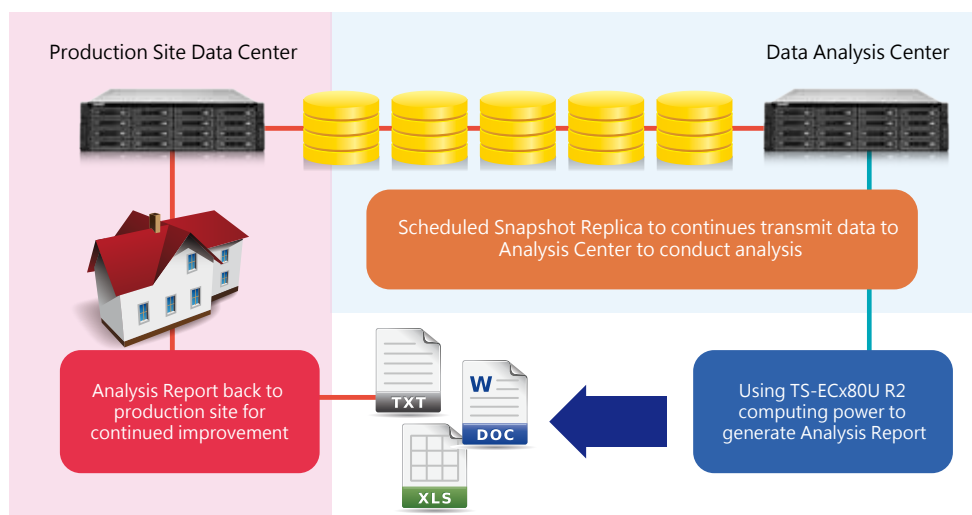



# File Station 4.2

Manage all files from a single management window

With the new remote connection function, the File Station now enables management of files on local, remote, and cloud storage across geographical boundaries and platforms from a single window anywhere.

In the past, you needed to log into different devices individually for data migration or copying.



Now, File Station 4.2 supports remote connection.

- Supports connecting to six cloud services: Google Drive, Dropbox, Microsoft OneDrive, Box, Amazon Cloud Drive, and Yandex Disk.
- Three remote device network protocols:
  1. CIFS: Supports online streaming and thumbnail display when Microsoft Networking (SMB/CIFS) is selected. Allows a single folder to be mounted on your local network or when the NAS connects to a VPN service.
  2. FTP: Allows every folder to be mounted when using the FTP service for easy access to remote data.
  3. WebDAV: Allows a single folder to be mounted on local network or over the Internet. WebDAV uses the HTTP protocol over the standard HTTP port, making accessing files via WebDAV similar to downloading files from a webpage.
- Also supports searching for devices on the same network via FTP or CIFS.

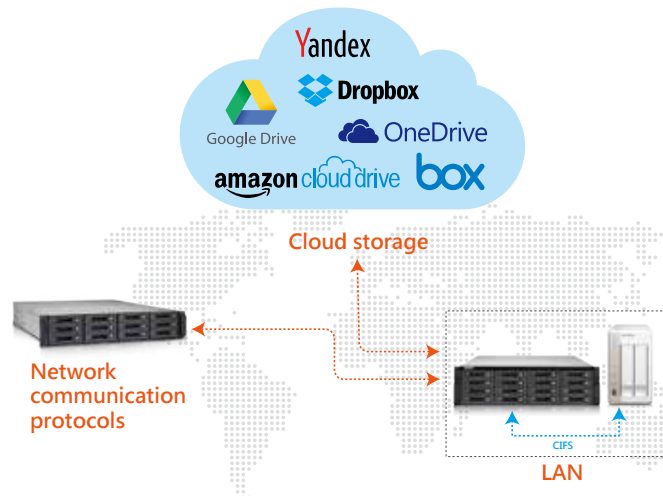

Manage all files from a single management program

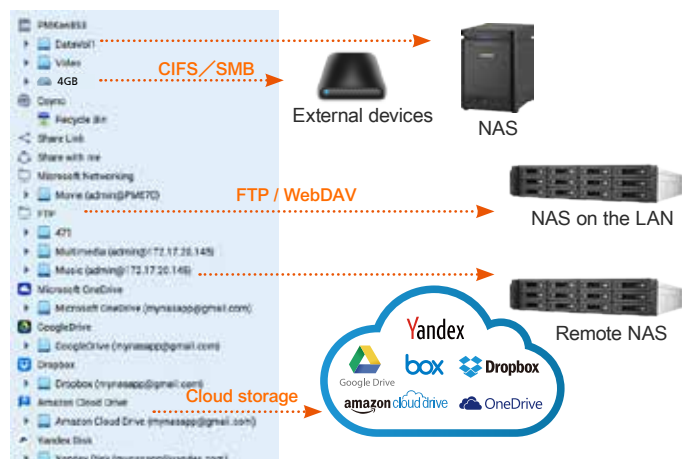

Note 1: Please install Connect to Cloud Drive from the App Center before connecting to cloud services.

## File Station interface

Three browsing modes are available: icon, list, and detailed list.

### Folders in tree structure:

Presents the locations of data in an easy-to-read format.

### Remote connection:

View remote connections here

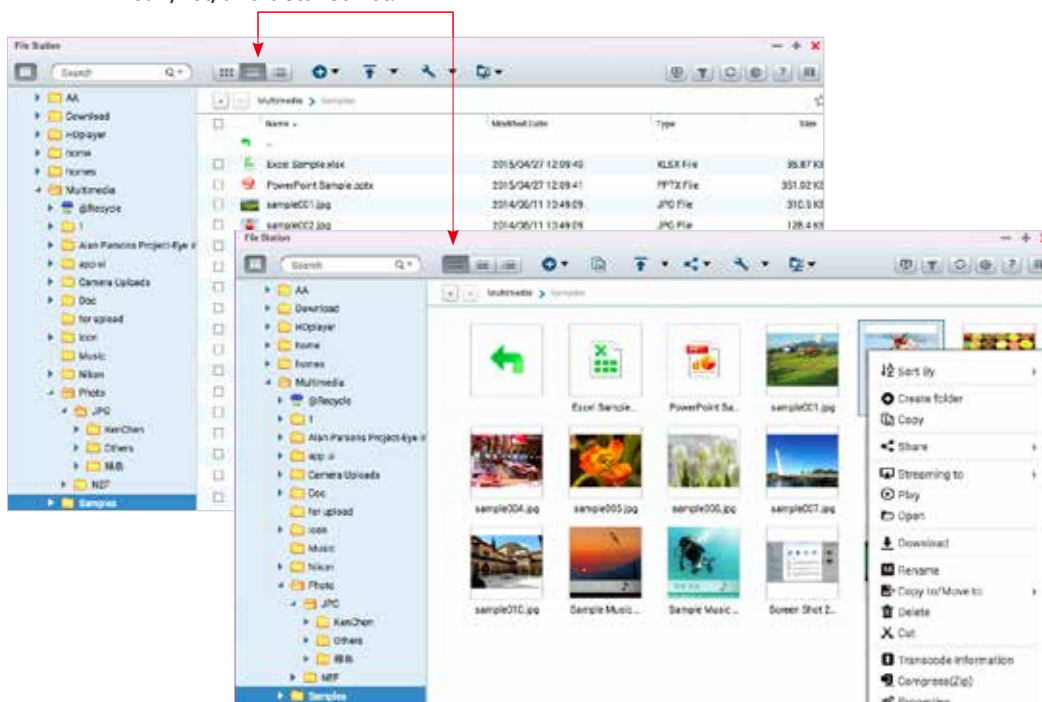

Features many functions for easier file management.

## Preview for Microsoft Office files:

- Preview Microsoft Office files offline with a Chrome browser extension (Chrome browser only and with the Office Editing for Docs, Sheets & Slides Chrome extension installed from Chrome Web Store) in the File Station.

Support for file types: .doc, .docx, .xls, .xlsx, .ppt, and .pptx.

Also supports the online preview of Microsoft Office files with Office Online and Google Docs in the File Station.

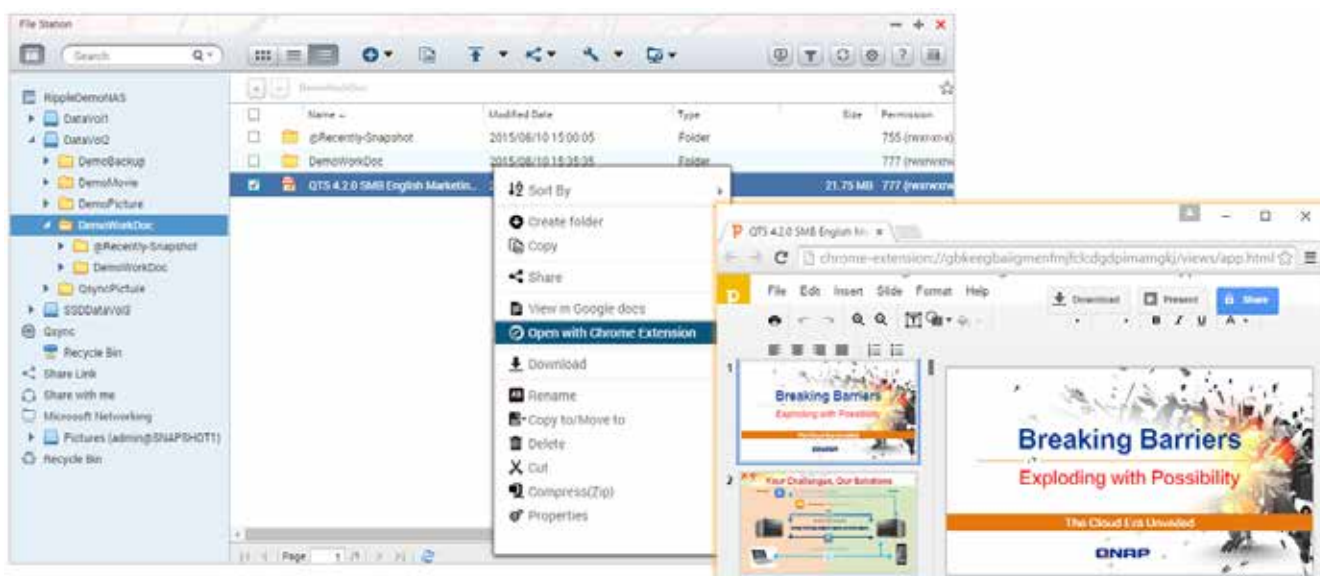

## Multimedia streaming

### Video:

- On-the-fly transcoding enables you to watch a video while it is being converted in real time. (Please note that on-the-fly transcoding is only available on certain models.)
- Background transcoding enables you to convert video into different resolutions and formats suitable for multiple devices and multiple networks.
- In addition, playback with VLC player for online video streaming is now supported.



### Photo:

- All new interface with added support for viewing a wider range of picture formats.
- Playback photos as a slideshow, or set a photo as the QTS wallpaper directly from the picture viewer.
- Additionally, photo rotation is now supported.



### Music:

- Added support for direct playback of even more music formats.

## Smart zonal streaming

Stream multimedia files to different devices via Apple TV, DLNA, or Chromecast from the File Station.

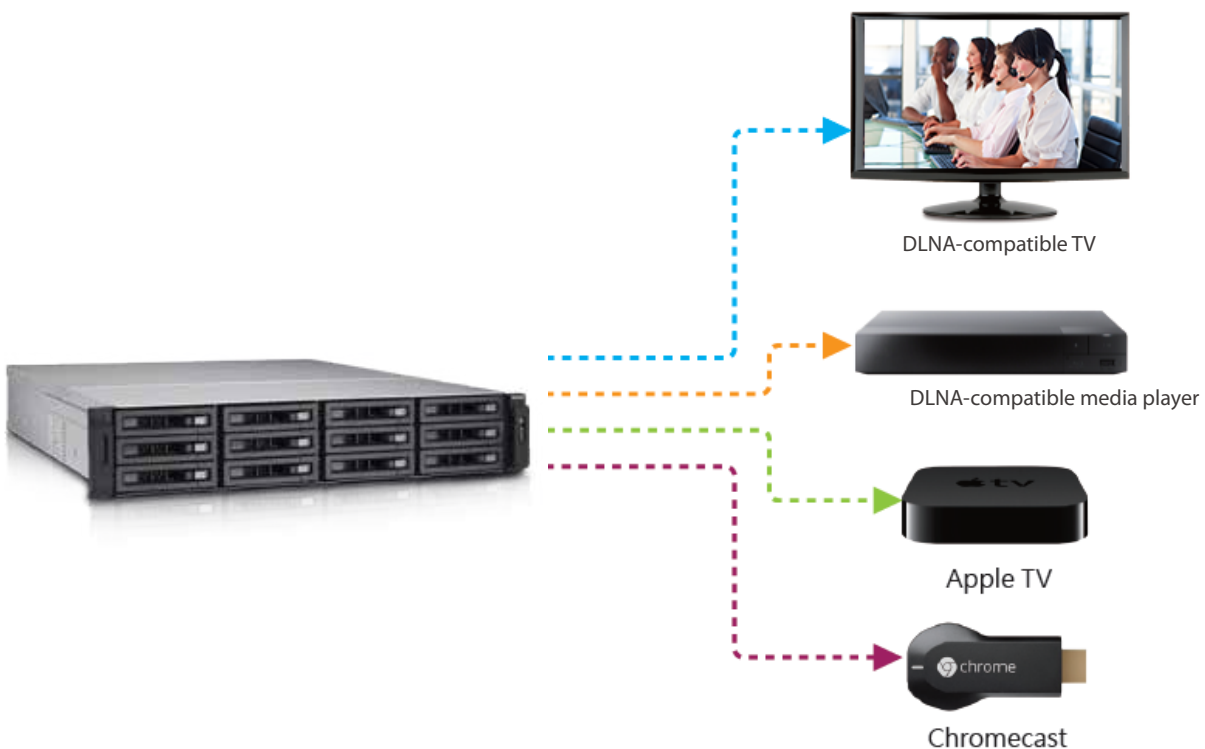



## Upgraded sharing functions

- **Share space with a user:** System administrators can allocate space to NAS users, and specify a storage quota in File Station.

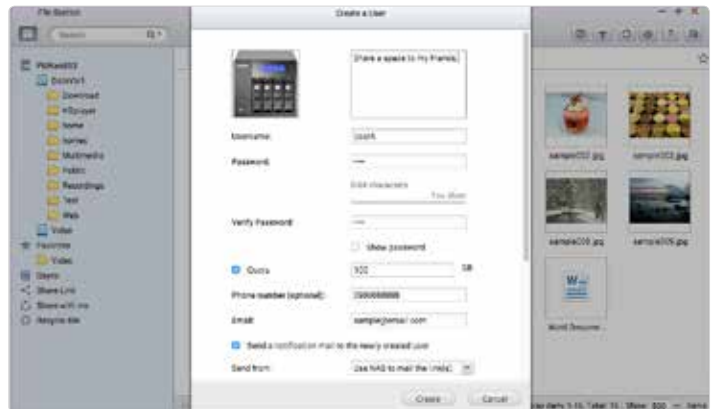
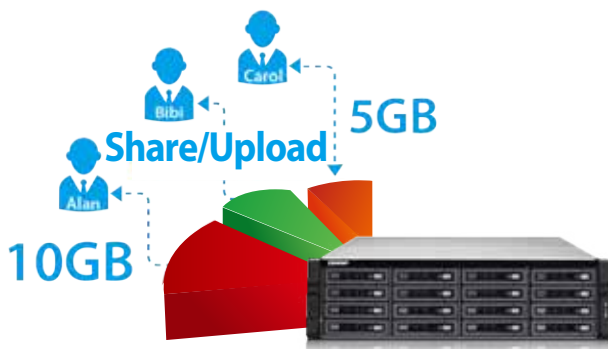

 Send users a notification of the access link via email when sharing space with a user to streamline the process.

- **Directly share with other NAS users:** Share files directly to selected NAS users rather than setting shared folder permissions.
- **CloudLink** enables file sharing from anywhere especially when your network environment does not support port forwarding. Just log in to myQNAPcloud from your NAS, create a share link with CloudLink, and then share the link with others.
- **Share download links via email:**
  - ◆ Users can share links from their own email account.
  - ◆ Supports multiple email accounts.
- **Share with social networks:** You can paste the Share Links on social networks of your choice.
- **Create share links only:** Create a share link for files or folders and copy & paste it into forums, websites, and instant messengers for others to access it.
- **Mutual file sharing:** You can easily share several files in a shared folder with friends via a Share Link. By enabling the “Allow file upload to this folder” option, your friends will be able to upload files to your File Station without a user account. Set an expiration time for shared files.

## File or folder operations and management

With File Station, you can easily carry out common tasks like uploading, downloading, and managing files.

- Streamlined file operations such as rename, copy, move and delete.
- **Compress/Extract multiple files:** Choose multiple files in File Station and select “More Actions” > “Compress (Zip)” to compress the files to a Zip file. Alternatively, you can extract content from a Zip file.
- **Instant photo preview:** File Station displays thumbnails of photos, album covers, and videos to aid in categorizing and organizing multimedia files.
- **File/Folder Property inspection:** You can quickly inspect a file or folder’s detailed properties from its Properties window.
- **Auto transcoding:** Set a folder as an auto-transcoding folder with its Properties window on the right pane. The Turbo NAS will automatically convert the videos in this folder to the resolution you have set.
- **Media Folders:** Similarly, you can designate a folder as a media folder and specify the type of files (photos, videos, music, etc.) that the media scanner should index from the Properties window.
- **File upload:** Move files from a local PC/Mac to File Station by drag-and-drop to upload the files to the Turbo NAS easily.



# Hybrid Backup Solutions

Hybrid cloud for a consolidated backup solution

The QTS allows data on PCs, servers, virtual machines, and external drives to be backed up to the Turbo NAS; and provides disaster recovery solutions to back up data on the Turbo NAS to external devices or remote servers.

## Backup from computer to NAS - PC backup

Windows® users can install the free QNAP NetBak Replicator utility to back up files from Windows® PC - entire disk drives, documents, pictures, music, videos, fonts, emails, and more – to one or multiple Turbo NAS units.

With simple clicks, you can set up real-time backup, scheduled backup and auto-backup. You can set power off after the backup is finished to save energy; file filtering to exclude files not to back up; and email notification when backup is completed.



## 3rd party backup software

QTS is compatible with various renowned backup software such as Acronis® True Image and Symantec® Backup Exec. Users that have adopted such backup software can immediately back up data from other sources to the Turbo NAS.

## Virtualization backup server

The Turbo NAS is compatible with VMware® ESX server, Citrix® XenServer, and Microsoft® Hyper-V, enabling your QNAP NAS to be seamlessly integrated to a virtualized environment as extended storage for data backup.

## QJBOD Express

The new QJBOD Express enables quick back up or migration of large amounts of data to local or to remote sites without using any network bandwidth.

San Francisco to Los Angeles: Initial transfer costs for 50TB data		
Method	Time cost	Bandwidth cost
100Mbps network	About 45 days	50TB
QJBOD Express	In two days	0

## Back up 50TB data to remote site

### 1 Back up data to the JBOD

Connect the JBOD and create an encrypted volume for backup. "Safely Detach" the JBOD after the backup job is completed.



### 2 Transportation

Transport the JBOD to a remote site.



### 3 Finish backup job

Connect and scan the JBOD. Create the final incremental backup job.



The remote NAS must support JBOD expansion to use this feature.

## Complete backup and access —anytime, anywhere

The explosive growth of data brings challenges of data protection and management. Unless an organization has the necessary knowledge and a disaster recovery strategy to protect and recover data, data integrity and data security will continue to present a problem. Hybrid Backup Restore assists you in managing and planning backup strategies (including local, remote-site, and cloud backups) with its centralized management capability even in the most complex data environments.

Creator	Job name	From	To	Schedule	Latest time & details	Next time & action
Admin	Material_Backup	Server Name	IP / server name Path	Realtime	2015/03/20 16:28 Synchronizing...	[Pause] [Stop]
Admin	Backup_Disk	Server Name	IP / server name Storage space Path	Manual No schedule	2015/03/20 17:00 Running: 75 % .16MB/s Elapsed Time: 2d2h,1min	[Pause] [Stop]
Incoming	2014_Backup	Server Name	IP / server name Storage space Path	Schedule Every Monday 18:00	2015/03/20 08:00 Running...	[Deny Access]
Admin	Backup_Disk	Server Name	Device Offline Storage space Path	Manual No schedule	Never	[Lightbulb] --/--/-- [Backup Now]
Admin	RemoteDevice	Server Name	IP / server name Storage space Path	Schedule Every 1st Sat 9:12:00	Never	[Lightbulb] --/--/-- [Remove Now]
Admin	Syncrealtime	Server Name	Storage space IP+Path	Realtime	Never	[Lightbulb] --/--/-- [Sync Now]

The HybridCloud Backup/Restore App will be available in the App Center in Q3, 2015.

## Local Backup

Use the One Touch Copy button on the front panel of the NAS to quickly backup data to or from external USB devices or disks.



## Remote-site Backup

With the RTRR service on the QNAP NAS, backing up data to your NAS is a simple and easy process. Your computer or your NAS can be the source, destination, or relay server during the backup process. Access or back up files with the "Remote Connection" function in File Station using Microsoft® file sharing (CIFS/SMB) or FTP to mount external folders as if they were local.





## Smart Version Control

Real-Time Remote Replication (RTRR) version control enables saving backup files to time based versions. In case of an incident, files can be restored to earlier backed-up versions specified by time and date. Smart versioning enables you to create backup versions hourly, daily, weekly, or monthly. Alternatively, simple versioning keeps a fixed number of versions for a given period and automatically rotates stored versions.

## Remote backup monitoring

System administrators can now monitor backup jobs from remote servers with QTS 4.2's Backup Station. The Incoming List displays the status of backup jobs from other NAS servers that use the current NAS as a target destination for their backup.

## Two-way shared folder synchronization

Use RTRR (Real-Time Remote Replication) service to set up real-time or scheduled synchronization of shared folders between two Turbo NAS units. With two-way synchronization, file backup consistency is improved and is especially helpful in synchronization and collaboration across departments and branch offices.

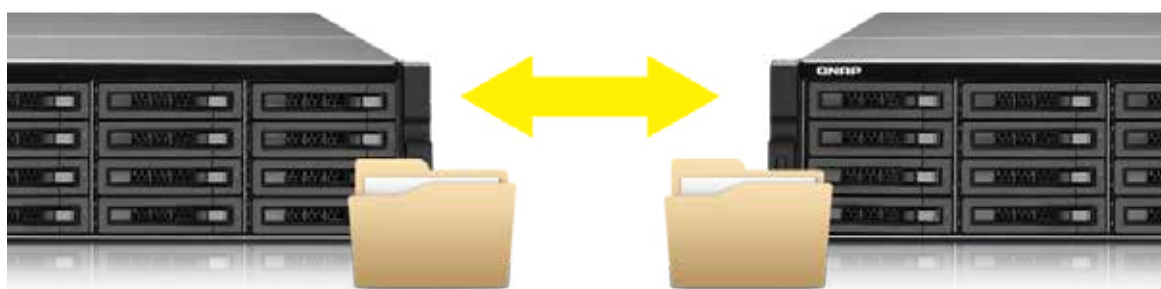

## Cloud Backup

Protecting against potentially disastrous data loss is of paramount importance for all businesses regardless of size. A QNAP Turbo NAS is a comprehensive backup and recovery solution to back up not only files for all devices on the LAN, but also for remote-site NAS units and servers. Furthermore, QNAP Turbo NAS fully supports backup from the Turbo NAS to online cloud storage services (e.g. Amazon® S3, Amazon® Glacier, Microsoft® Azure, Google® Cloud Storage\*, IBM® SoftLayer, HP® Cloud, Rackspace®, and ElephantDrive®). The QTS powerful and comprehensive Backup Station makes backup and recovery simpler for all business's disaster recovery plan.



## Cloud backup made simple

### 1 Compress

The CloudBackup Station supports compressed backup files, scheduled file deletion according to users' specifications and sparse file detection to avoid backing up unnecessary files. You can screen files by type, size, and date to ensure only the required files are saved on the cloud for greater storage and cost efficiencies.

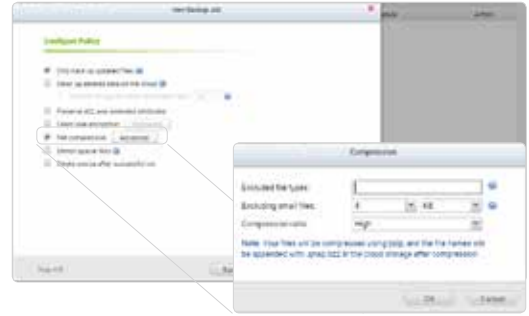

### 2 Select folder and encrypt

The CloudBackup Station features an SSL-secured connection and military-grade AES 256-bit data encryption to protect your data in transmission and at rest on the cloud.



### 3 Multi-thread transmission

The CloudBackup Station supports multi-task processing and multi-threaded data transfer\*. The latter improves file transmission speed and enhances work efficiency by segmenting large files into smaller ones before uploading. You can preview files in the cloud and download individual files instead of the entire folder.

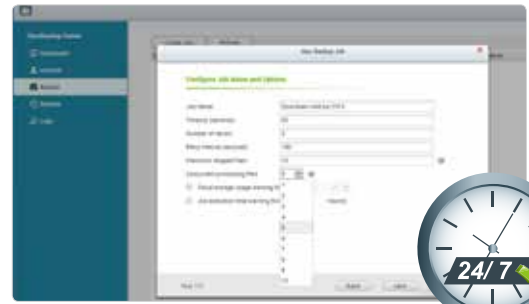

WebDAV app does not support multi-threaded data transfer.

## Cloud sync solutions

HybridCloud Sync supports four leading cloud storage services and synchronization with designated folders. The HybridCloud Sync supports Amazon® Cloud Drive, Google™ Drive, Dropbox™, and Microsoft® OneDrive® for continuous synchronization between your NAS and cloud storage.



### Microsoft® OneDrive for Business

Microsoft® OneDrive synchronizes personal files to their free online storage space while its commercial counterpart provides online storage space for enterprise users and use of Office Online.



### Amazon® Cloud Drive Unlimited Photo Storage Plan

This service can save not only photos but also videos and other files.



### Google™ Drive for Work

This service enables users to save all their work in a secured cloud environment to allow access from anywhere and at anytime, convenient sharing among colleagues with unlimited storage space.



### Microsoft Office® for Dropbox™

This service enables editing of Office files directly from Dropbox on the web.



# QPulse™

## Unified Remote Server Management Solution

QPulse™ is a Centralized Remote Server Management solution from QNAP designed for IT Teams. QPulse™ Monitors and controls the pulse/health of all the mission critical servers in your network. QPulse™ provides single point solution to Discover, Map, Monitor, and Manage all the critical computing devices (Servers/PCs/Thin Clients, etc.) in your network. Manage your servers from multiple clients with-in the same network or remotely.

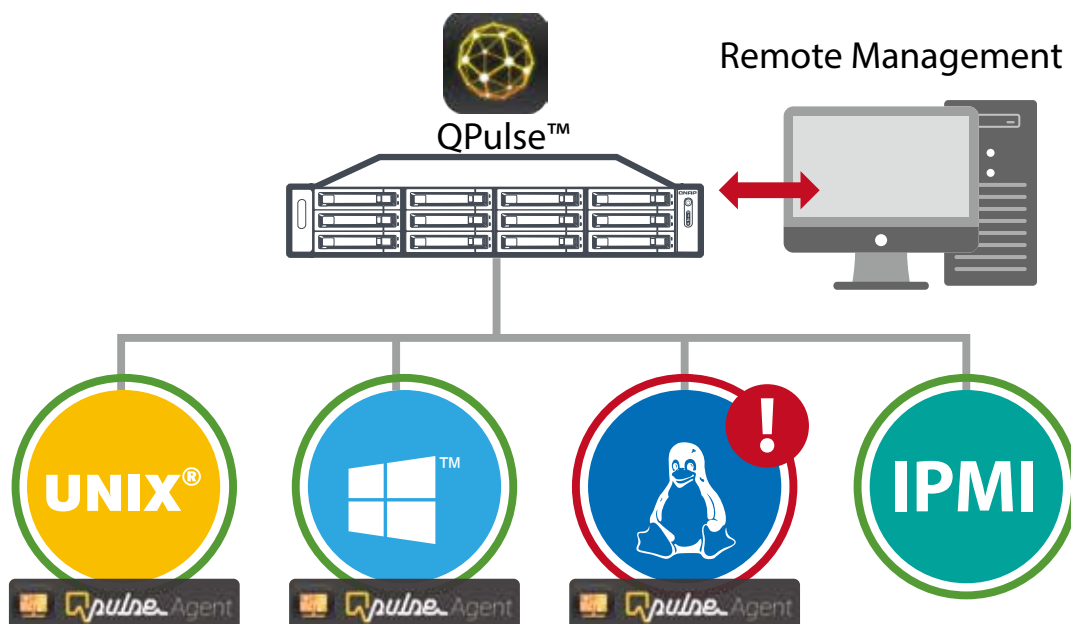

### Key Benefits

#### Server Monitoring Made Easy

- ◆ Increase IT's visibility across the health of mission critical servers.
- ◆ Discover, Map, Monitor, and control your networked resources from a single platform.
- ◆ Keeps track of all important device parameters and provides state of art alert/event management.
- ◆ Generates Reports to help you analyze performance of your networked resources.
- ◆ Supports multiple platforms like Windows and Linux through QNAP's QPulseAgent- A lightweight Remote Management Agent
- ◆ Supports IPMI 1.5 and 2.0 (IEI iRis-2400, iRis-1010 compatible).
- ◆ Spend less time in troubleshooting.



Discover



Map



Monitor

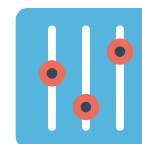

Control



### Customizable Dashboards

#### Server Monitoring Made Easy

Visualize and Monitor all the devices and respective parameters via QRMS Dashboards. Customize the Dashboard as per your preferences.

Multiple graphic and informative widgets provide a simplified monitoring system for your network.

## Device Discovery and Topology

### Discover and Map the assets in your network

QPulse™ identifies all the devices on your network including routers, switches, printers, servers, workstations, and mobile devices. Discover all the devices on your network using an IP Range scan. QPulse™ maps discovered devices into a topographic network map. Apply labels and other pertinent information to personalize your topographic map for quick reference and filtering. Network maps are a powerful first response tool that assist you in visualizing your networks and quickly isolating the root cause of a problem.



## Web Based Application

### Server management made easy

QPulse™ is a centralized, web-based solution accessible to your IT administrators from any web browser. QPulse™ supports many active monitors including CPU, Memory and Disk Utilization in addition to CPU Temperature, CPU Fan speed, and many more. This gives complete visibility to administrators across all mission critical computing devices. State-of-the-art alert mechanisms help IT staff to define and receive alerts across numerous parameters providing deep insight for full preparedness, prevention, response, and recovery.



## Remote KVM Solution for IPMI

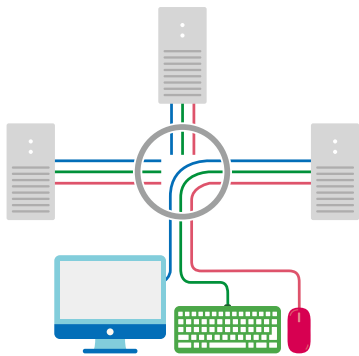

Remote KVM over IP in Browser

### Multichannel/Centralized Remote KVM solution

With QNAP's Proprietary KVM Proxy solution for IPMI compatible servers, you can remotely control the server even if server is turned off or is in BIOS mode. QPulse™ KVM solution supports multichannel access so that more than one client can connect to the remote server using KVM at the same time.

QPulse™ supports Remote desktop for non-IPMI devices based on noVNC technology.



## Remote KVM Recording and Playback

### Track all the actions using KVM Recording and Playback

Enable KVM recording and all the KVM data will be recorded in video format in the NAS. This way you can playback the recording based on Date and Time and track the events. This provides unique way to administrators to log each action taken on server and improve the security.



KVM Recording and Playback



# Q'center CMS (Central Management System)

Visual management platform for multi-NAS management

Previously, IT administrators needed to log in to QNAP NAS units individually to check their status. The QNAP Q'center CMS (Central Management System) offers a platform to centrally manage multiple NAS units. The simple setup, cost effective, convenient and flexible approach that Q'center delivers greatly improves management efficiency for IT administrators.

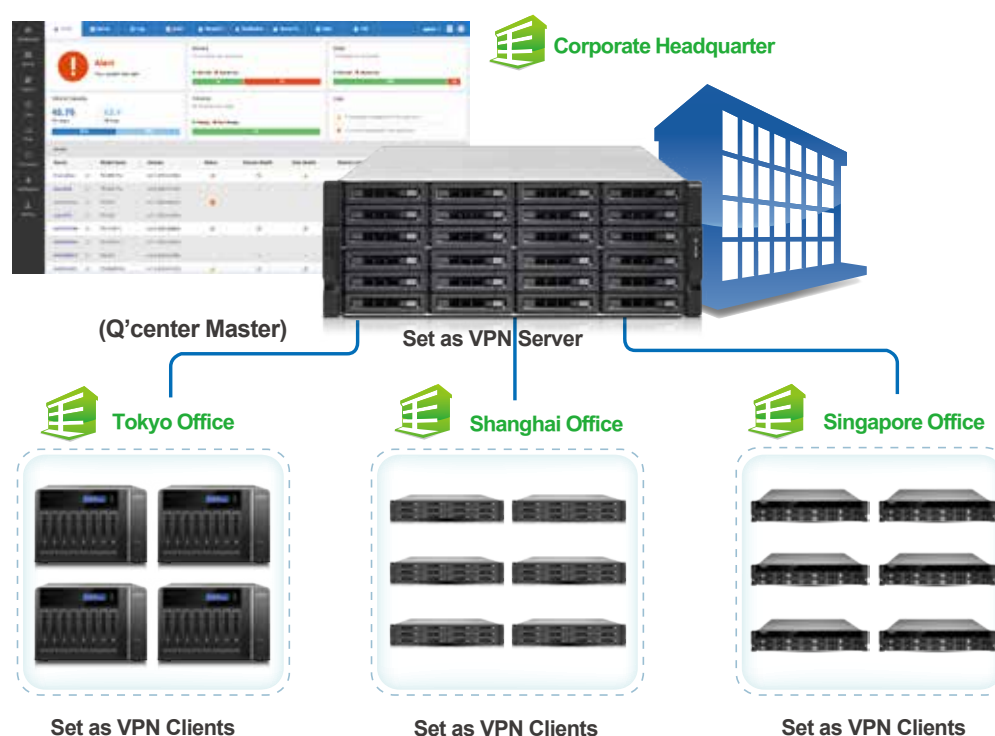

## The Best Utility for IT Administrators

Q'center is a powerful QNAP NAS management tool. You can view the status and system information of multiple NAS units at the same time from the Q'center Server. You only need to install Q'center on the master NAS and set all other QNAP NAS units as managed stations, and all their relevant system information can be easily checked on the Q'center Server. Q'center can greatly assist IT administrators and QNAP NAS users in system resource allocation and future capacity planning.

## Central Management Platform

The "Dashboard" screen provides you with tools to conveniently inspect and monitor system status for all connected NAS units and allows you to efficiently review system logs of selected NAS units. You can customize dashboards to get a quick overview of specific system information or statuses and alerts.

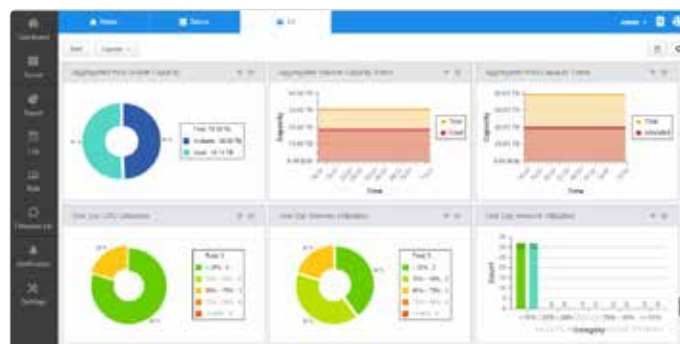



## Visualized Statistics

The visualized statistics and messages allow you to rapidly gain a clear picture on the system statuses of all QNAP NAS units, including disk usage, shared folder space usage, HDD IOPS, HDD delays and CPU usages and use them as the basis of your system utilization trend analysis.



## Centralized platform

You can use Q'center as a centralized platform to enable network services and other settings on a group of NAS units at once or a specific NAS unit. Q'center can also act as a firmware storage center and be used to store historical firmware versions or schedule firmware updates for all NAS units or a specific NAS unit to improve efficiency for IT operations.

## Designed for all IT environments

You can use Q'center as a centralized platform to enable network services and other settings on a group of NAS units at once or a specific NAS unit. Q'center can also act as a firmware storage center and be used to store historical firmware versions or schedule firmware updates for all NAS units or a specific NAS unit to improve efficiency for IT operations.

## Manage QNAP NAS behind firewalls

The exclusive firewall penetration technology from QNAP enables Q'center to connect different QNAP NAS units in different geographic locations and subnets. Using Q'center Agent, you can quickly establish connections between NAS clients and the Q'center server, saving you the trouble of complicated router and VPN settings.



## Q'center for VM

QNAP also offers the Q'center version to run on VMware and Windows Hyper-V. You can install it in VM without a QNAP NAS, adding flexibility to your setup choices.

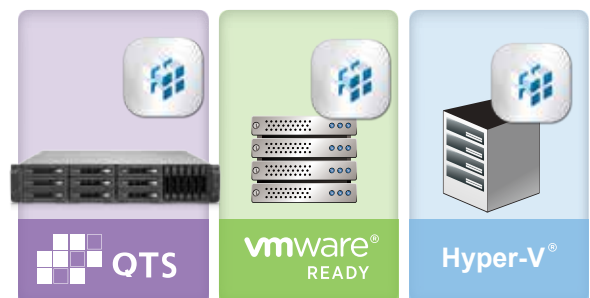



# Virtualization Station 2.0

Features external graphic card support and shared network interfaces

Virtualization Station 2.0 eliminates the constraints that exist on conventional VMs (poor graphics and slow network speeds) to provide a better user experience. Create multiple VMs on a QNAP NAS and install Windows, Android, Linux, and UNIX so that every VM can serve in a different role. One QNAP NAS can literally be every type of computer you need.

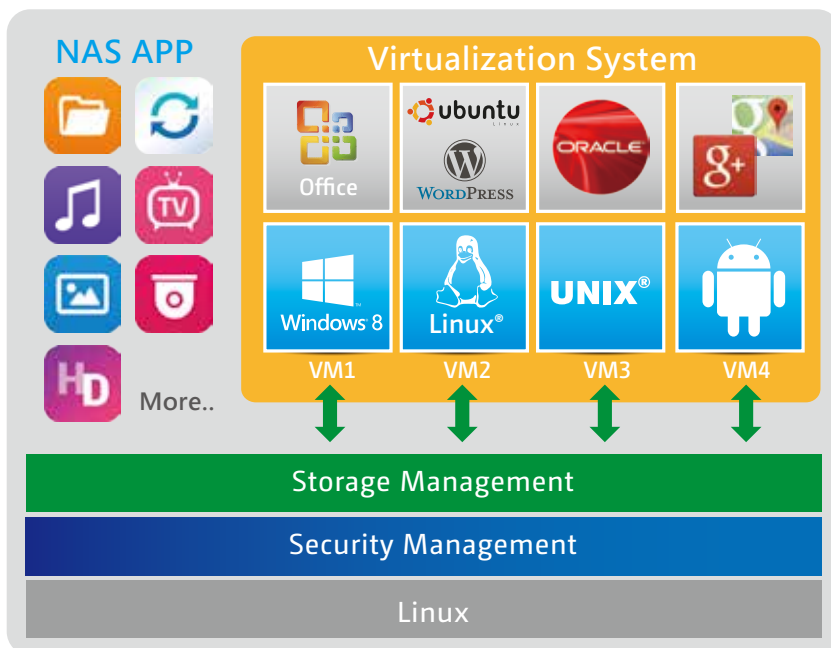

## QNAP advances in VM network structure, again — The Software Defined Network

A dedicated VM Ethernet port, taking up a 10 GbE LAN ports is no longer needed. By adopting a Software Defined Network approach, VMs can now share the network interface with the QNAP NAS to maintain the best data transmission speed without being limited by hardware resources.

Previously, virtual machines required dedicated network ports.



NAS VM

Now, virtual machines can share network ports with the NAS.



NAS VM

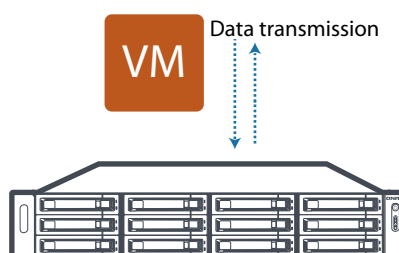
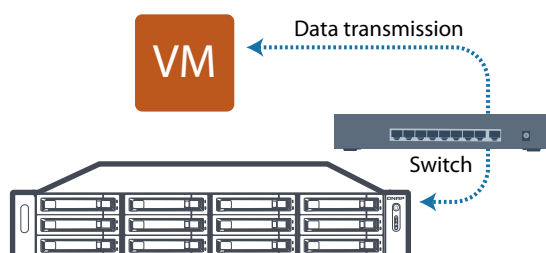

## Software-defined Switch

By adopting a Software Defined Network (SDN) approach, VMs can now share the network interface with the QNAP NAS to maintain the best data transmission speed while allowing users to define their own network mode, potentially enhancing deployment flexibility and network security.

The SDN-based architecture consists of an Application Layer, a Control Layer, and an Infrastructure Layer. At the Application layer, the VM orchestrator manages workload schedules through communication with the Hypervisor. When the VM Orchestrator receives a transmission request from the Hypervisor, the VM Orchestrator will signal the vSwitch Controller (as the NAS's network control), and then the vSwitch Controller of the control layer will dynamically adjust the Hi-speed Virtual Switch so that VMs can connect with the Physical Networks or NAS storage for data communication. By employing a high-performance virtual switch VMs are no longer confined to the limits of the transmission speed of the physical NICs when transmitting data between VMs, or between VMs and the NAS.

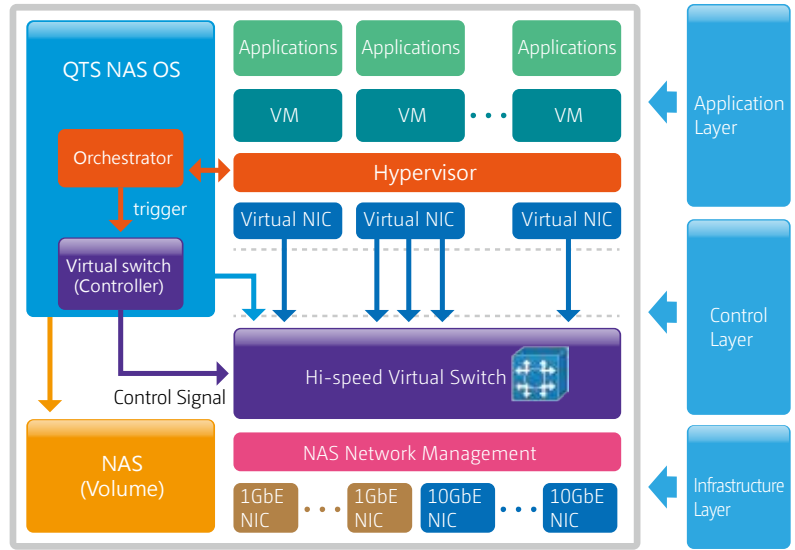

## Virtual Switch

Virtual Switches are an efficient and effective network design when compared to dedicated network ports. Virtual Switches enable VMs' to share Ethernet interfaces removing the need for a dedicated VM network. Bypassing the need to transfer data through the physical network equipment also boosts the transfer rate between VMs and the NAS. The Virtual Switch is capable of 10 GbE and port-trunking, enabling you to obtain a fast and secure network environment.

## Support Networking modes of Virtual Switch

- Bridged Networking

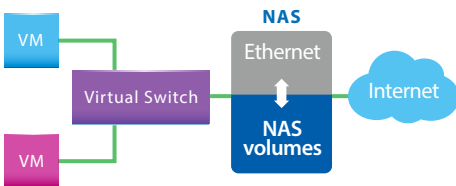

Attaching an Ethernet interface (Port-trunking available) to a Virtual Switch creates a bridged network. The NAS and the Virtual Switch can share the same Ethernet interface without occupation and supports high-speed data transfer via internal routing.

- External-only Networking

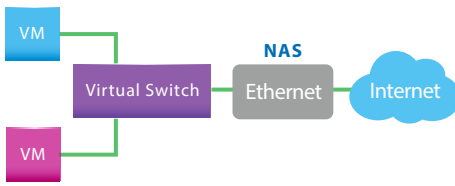

Specify an Ethernet interface for a Virtual Switch to enable dedicated routing between virtual switches and external networks. Enable DHCP to automatically assign an IP address to a Virtual Switch or choose to manually assign an IP address.

- Isolated Networking

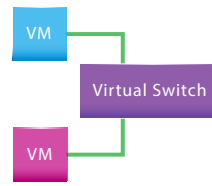

Not attaching any Ethernet interface to a Virtual Switch creates an isolated network. Manually setting IP address of VMs can enable communication between VMs connected to the same Virtual Switch.

\* Available port-trunking modes: Active Backup, IEEE 802.3ad, Balance-tlb.

## QVM supports 4K displays, audio output

QVM in the HybridDesk Station enables the use a VM as a PC simply by connecting an HDMI monitor, keyboard, and a mouse. QVM offers 4k resolution and virtualized audio output to support a wide variety of applications. Using a browser with HTML5 is limited to 1080P without audio. This makes QVM ideal for video applications.

noVNC is an HTML5-based remote desktop web client that can communicate with a VM. noVNC does not support audio transmission. For audio output, use Windows Remote Desktop or the SPICE Client to connect to the VMs.



## VM backup and restore

With Virtualization Station, it is effortless to manage multiple virtual machines on a QNAP NAS. They can be backed up/restored centrally using an easy-to-use interface, and users can obtain scheduled tasks/status, and manually start or stop backup tasks. The online backup tasks run in the background without interrupting VM operations and/or powering off the system. Furthermore, you can set the schedule for backup tasks and maximum number of backup copies. When restoring, the system will automatically start up the restored VM, simplifying the whole process and reducing system downtime.

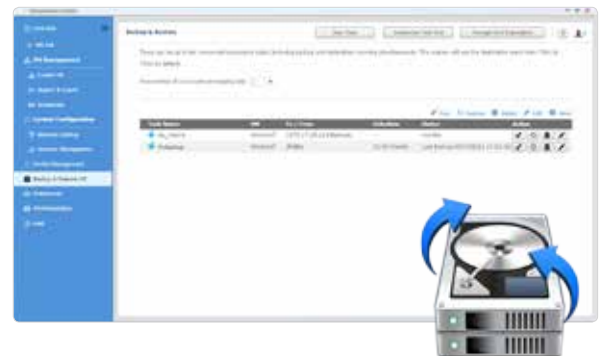

## Device management

The Device Management screen provides an overview of all VMs, keeping you informed of the storage capacity, network interface, and USB devices of the NAS as well as letting you connect or remove a new device.



## Virtual machine import/export

Virtual machines of various formats can be easily imported to and exported from the Virtualization Station. IT administrators can get VMs up and running quickly on a QNAP NAS or other Hypervisors.

## USB devices (USB Pass-through)

Virtualization Station supports connecting USB devices to virtual machines. Commonly used USB devices such as storage devices and card readers can be connected to virtual machines, and you can select a specific device using Virtualization Station. This can be used together with QVM Desk just like a PC. You can also connect USB card readers/scanners to a QNAP NAS via Virtualization Station and store scanned data directly to the NAS without taking up Internet bandwidth. Further, with the advent of USB 3.0, higher data transmission can be easily achieved.

Please note that this function is only available on Windows 7 (requires the manual installation of extra drivers), Windows 8, Windows 8.1, Windows Server 2008 R2\*, Windows Server 2012 and Windows Server 2012 R2.

## Seven advantages of QNAP's exclusive virtualization technology



- Save bandwidth & time

Downloading a large amount of data to a local PC can take a long time and use up network bandwidth. When accessing data on the Turbo NAS through virtual machines on the Virtualization Station, you can enjoy secure data transmission and save bandwidth & time as the data is not transmitted via physical network cables.

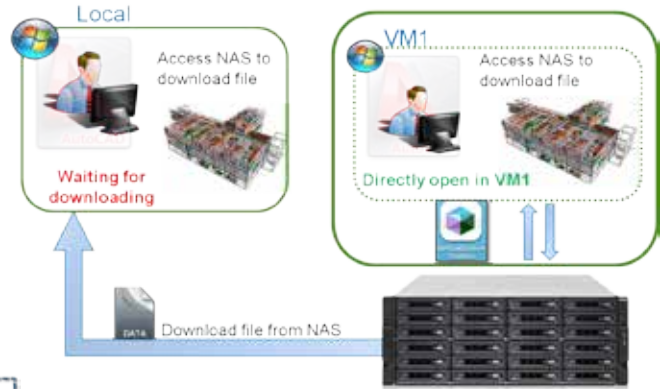

- Enhanced security

When accessing files & data on a virtual machine they are not transmitted outside of the Turbo NAS. This provides a secure environment that prevents sensitive data from being intercepted and saves bandwidth and network resources when accessing large files.

- User-based permissions settings

The Virtualization Station administrator can create users and set granular permissions for each Virtual Machine (VM), helping to efficiently manage and allocate VM resources for users with different needs. With these permissions, users can work independently on their VM without worrying about their work being interrupted or data being lost because another user has accidentally powered-off the VM.

User-based permissions include: Console permissions: Control and View-only. VM controls: Snapshot and Advanced

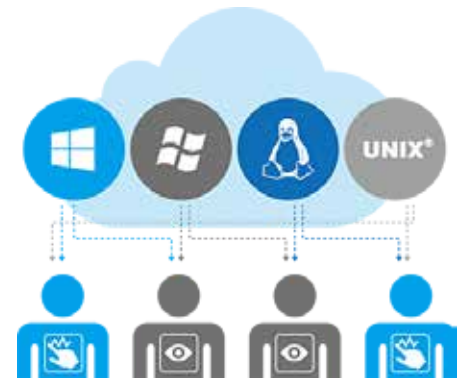

- Operate VMs as Remote Desktops

Enjoy the convenience of operating Windows, Linux, and UNIX-based VMs as remote desktops. A list of buttons is provided on the left side of each individual VM display, allowing users to suspend, shutdown, force shutdown, reset, bring up key combinations: Ctrl +Alt+ Del and function keys, and take snapshots of the VMs.





# Container Station 1.0

The new era of virtualization and cloud computing

Container Station provides an agile, top-of-technology development platform bridging computers, Turbo NAS, and public cloud for developers and system administrators. Container Station that QNAP introduced in 2015 is developed following the Just enough OS, or JeOS, philosophy. This lightweight virtualization technology can instantly and truly create a ready-to-use environment on PC's, Turbo NAS and the Cloud for RD developers and IT administrators. For example, you can build a project in Container Station on your home computer. After the completion of each development state, upload the container to Docker Hub or export and save it on the NAS. Your coworkers can then download the container and continue with the next development stage. With a container-based application, on QNAP Turbo NAS, VMware, OpenStack, or on the cloud, developers can deploy and share any app on any of these platforms, quickly and reliably.

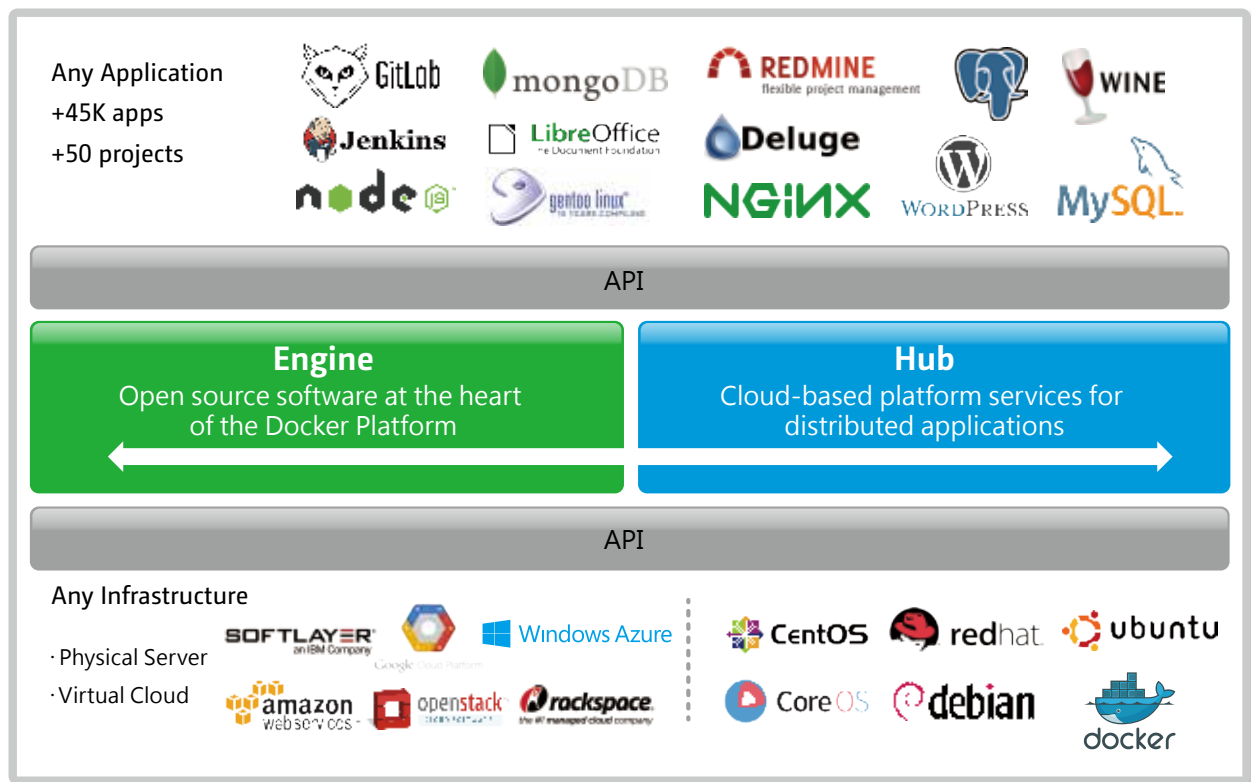

Container Station is available in the App Center.

Docker and the Docker logo are trademarks or registered trademarks of Docker, Inc. in the United States and/or other countries. Docker, Inc. and other parties may also have trademark rights in other terms used herein. Linux® is the registered trademark of Linus Torvalds in the U.S. and other countries.

## Benefits of Container Station:

- 1 Embrace Docker technology to seamlessly bridge NAS and cloud applications in a hybrid cloud infrastructure.

With Docker, applications can be uploaded (pushed) from the NAS to a public cloud at anytime from anywhere, shortening development cycles and increasing testing speed.

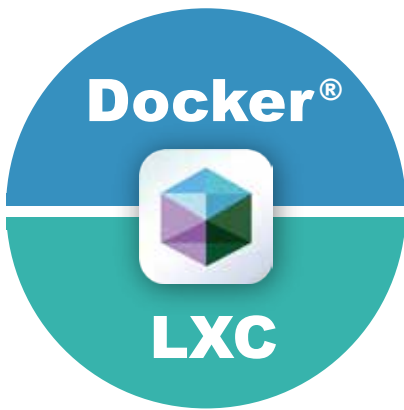
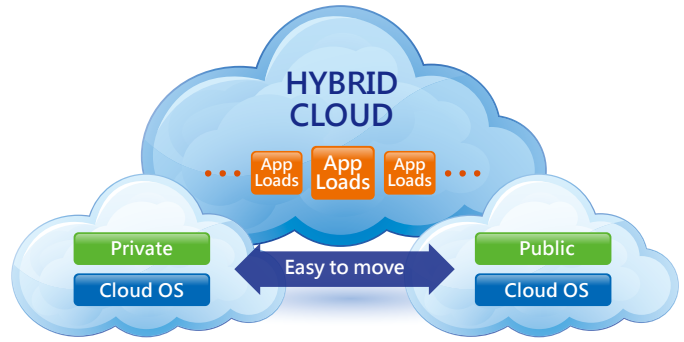

- 2 Integrate LXC and Docker to bring even more value to your NAS

LXC—the lightweight Linux Container enables a high-performance lightweight virtualized Linux environment on your NAS. Install a lightweight version of Linux as the base for your containerized application with LXC.

Docker—Facilitates fast and mass application deployment to build microservices.

- 3 A wealth of shared applications

Use the Docker Hub to search for publically shared applications, whether they are databases, web servers, programming languages, or development tools; install it as you would an app on your smartphone.

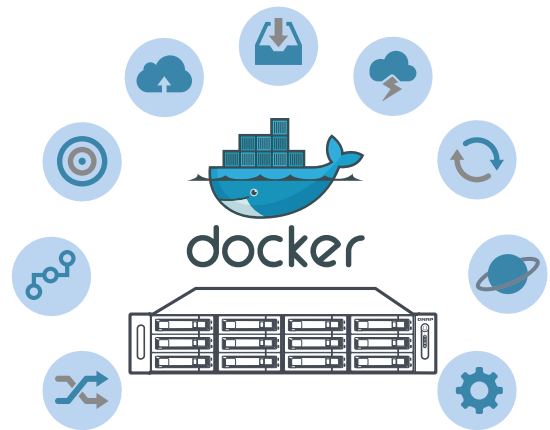

- 4 Easy cross-platform deployment

LXC/Docker has been widely adopted by many public cloud services. Containers run on almost any platform, including PC, servers, VMs, and public and private clouds. Container Station with Docker streamlines application deployment and migration on virtualized and cloud environments. Using Turbo NAS with Container Station enables seamless integration with major public cloud services.

- 5 Excellent virtualization performance

Instead of virtualizing hardware, containers rest on top of a single lightweight Linux instance. This makes it possible to quickly set up and run containers from the same host where each guest has a unique operating environment isolated from its host and with performance close to that of a physical server.



## Seven exclusive and industry-leading functions

### 1 One-click installation

Forget complicated configuration and simply enjoy the benefits of software containers. Just click “Create” and the system will automatically download and install the applications.



### 2 Lightweight virtualization—LXC

LXC is now available in Container Station. It features the most common operating systems including Ubuntu, Debian, and Fedora built-in. Users can add desired applications after downloading.



### 3 Automated deployment

Wondering how to set up software containers? QNAP's exclusive automated deployment function makes using software containers very easy, enabling rapid installation and deployment.



### 4 Virtualization on NAS for home and small offices

Entry-level NAS models, e.g., TS-231+, TS-431+ can enable Linux virtualization on QTS 4.2. Just download the default Linux version from Container Station and you can have the only virtualization-ready ARM-based NAS.

### 5 Operate software containers via URL or terminal

The Container Station automatically provides links to web-based applications to streamline software development throughout the entire process. In addition, the console provides a familiar development environment for Linux experts.



### 6 Export/import software containers

You can export software containers along with data contained in it to a given shared folder. You can also import software containers from PC or shared folders. Employs this function to back up as well as transfer your containers at ease.



### 7 Auto start up

Your software container starts automatically after your Turbo NAS powers on or after Container Station reboots. This eases system administrators' workload while improving the system availability.

## Other functions

### Resource management

Specify host CPU/memory resources allocated to a software container and monitor the host in addition to each container's performance from a single screen. The visualized presentation with graphics provides a quick overview of resource consumption and aids in resource management.



### Access shared folders

Shared folders mounted in a container (or from other containers) save data to the NAS at comparable access speeds to that of bare metal environment.

### Permission control

Access shared folders on the NAS or other containers as well as connect to other host servers with granular permission control.

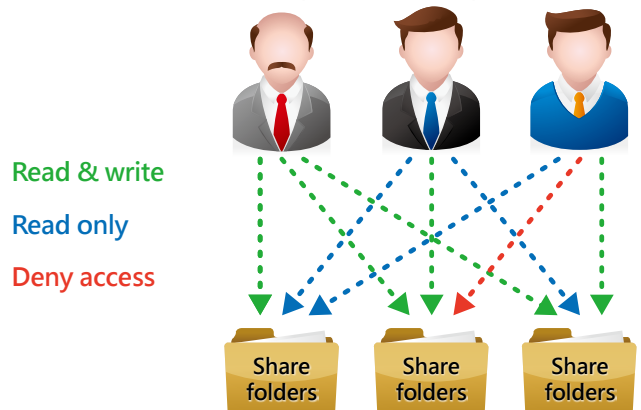

### QNAP customized LXC/Docker images

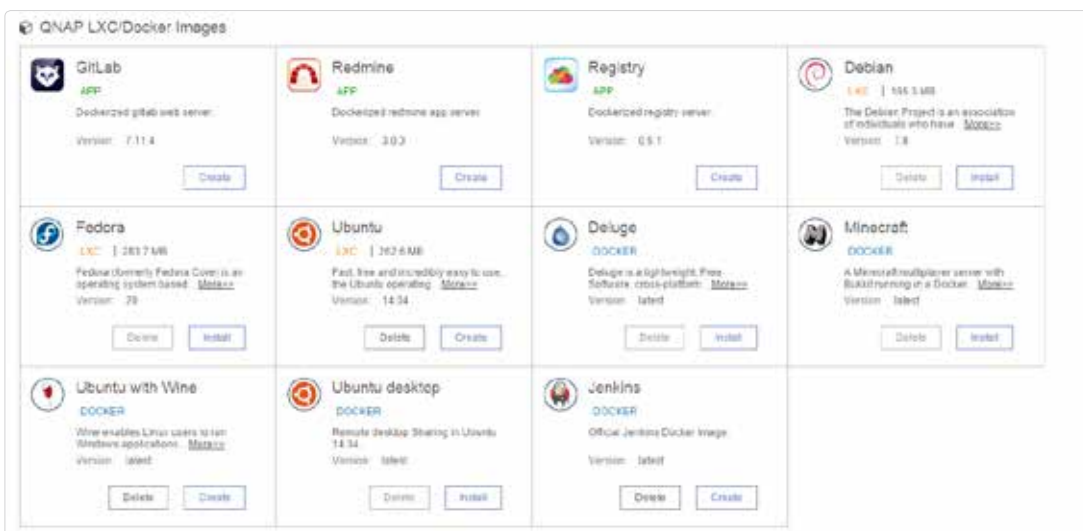



# QNAP QvPC Technology

Use the NAS as a PC

With the growing trend of "Software-defined everything (SDx)" in today's IT environments, QNAP has taken the lead in tightening hardware-software integration and offering the exclusive QNAP virtualized Personal Computer (QvPC) Technology that allows you to use the Turbo NAS as a PC. All you need to do is plug in a monitor, keyboard and mouse to be able to operate the system via "HD Station (HybridDesk Station)" on the screen.

## About QvPC Technology

Based on Software-defined Everything, QvPC Technology is the result of years of R&D effort that QNAP has put into developing and perfecting its software and hardware expertise. QvPC Technology has consolidated a number of high-end technologies and latest IT trends including VM integration, multimedia transcoding, HDMI output, cloud integration, and NAS connection technologies, allowing users to operate a Turbo NAS as a PC when they plug in a keyboard, mouse, and monitor. QvPC Technology can turn a NAS into a low-cost & high-performance 2-in-a box NAS that can function as a NAS and a PC. Whether you are working in a studio or at a remote site, you are assured to receive the best user experience.

QvPC Technology features HybridDesk Station (HD Station) as the user interface, which consists of QVM Desk, Defense Desk, and Local Display Desk and provides SMBs numerous software applications.



Connect a monitor with a HDMI cable, and you can enjoy a variety of applications with HD Station 2.0. You can initiate the service in QTS system and install different applications according to your needs.



\* All trademarks in this brochure are the property of their respective owners.





## The highlights of QNAP's exclusive QvPC Technology

HD Station 3.0 is a monitor-based user interface based on QNAP's exclusive QvPC Technology. Simply plug in a keyboard, mouse, and HDMI monitor to a Turbo NAS and you can start the installation process and access data without connecting to a PC, tablet, or smartphone. A variety of applications are available on HD Station including QTS, Mozilla Firefox, Google Chrome, QVM, XBMC, and Surveillance Station. To increase data safety, HD Station 3.0 employs controls on user login to allow only authorized users to access data on the Turbo NAS using QvPC Technology.

 HD Station also supports touch panels to control the system directly through a screen.



## Run Windows, Linux and Android virtual machines on a HDTV



Leveraging virtualization technology, QNAP QVM Desk supports local display for a virtual machine and turns the Turbo NAS into a PC when connected to a HDMI monitor, keyboard, and mouse. Any files on the Turbo NAS can be opened using virtual machines running Windows, Android, Linux, and Unix through QVM Desk. You can also instantly switch between different virtual machines to meet different computing needs, similar to using multiple PCs at the same time. Compared to the operations via a webpage, it is smoother, more secure, and worry-free on a Turbo NAS. Even when the Internet connectivity is limited, you can still access data and run virtual machines on a Turbo NAS.

## QNAP QVM Desk turns a Turbo NAS into an office PC

- Streamlined installation: No complicated procedures necessary to install your Turbo NAS

After purchasing a Turbo NAS, users usually install firmware from an installation disc and search for the Turbo NAS on their network, or log in to the NAS manufacturer's website to complete the installation process. For users without relevant networking knowledge, this installation process may be difficult. Some users decide to purchase other external storage devices that can be instantly used (such as USB hard drives). However, these devices are "islands of information" that can only be accessed by the computer they are connected to. These storage solutions also offer no protection against failure, and are easily misplaced.

A Turbo NAS is an ideal solution for storing data. With QvPC Technology users only need to plug in a HDMI monitor, keyboard, mouse and follow on-screen instructions to complete their NAS installation. Even users without any network knowledge can easily set up and install a Turbo NAS. All files stored on a Turbo NAS are protected with RAID technology and are accessible via the Internet anytime.

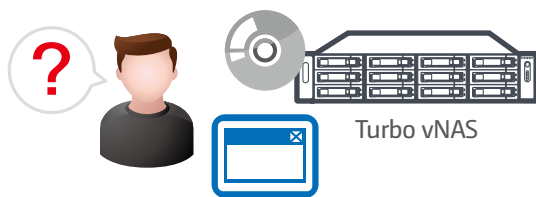

Conventional installation: You need a disc or to log in to a website to complete the installation, and it can be complicated for general users.

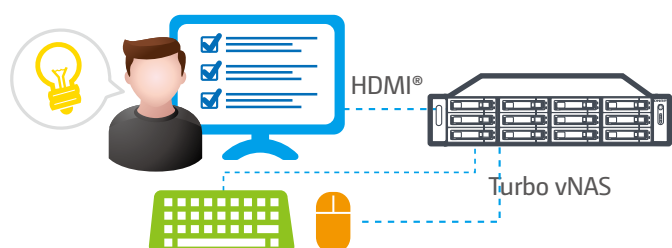

Streamlined installation: simply plug in a monitor, keyboard and mouse and follow the on-screen instructions to complete the installation.

## Defense Desk 24/7 safeguards your office and property

- Live-view

QvPC Technology supports local display of live surveillance feeds on-screen with a QNAP remote control. You don't need an additional PC for live-view, nor do you need an Internet connection to check the stored video recordings. You can monitor up to 36 channels simultaneously, adjust PTZ functions, and conduct audio surveillance. QvPC also supports instant notification functions and will show alerts on the monitoring page should any incident happen. This ensures you are able to respond to incidents immediately and more efficiently.

- Playback

Connect your Turbo NAS to a monitor to playback recordings. Just select a timeframe and you can search the recordings within that period. It also supports video fast-forwarding and rewinding (up to 16x speed). You can quickly look for detailed images with the zoom function, and listen to audio for key background sounds during the playback.



## Manage Local Display Desk easily

Just plug in an HDMI monitor/TV, keyboard, and mouse to a Turbo NAS, and with a few simple steps you will complete installation and be able to access files using the QTS operating system.



# Virtualization Applications

## VMware® / Citrix® and Hyper-V

The Turbo NAS supports iSCSI and NFS protocols, and is virtualization ready - VMware Ready™, Citrix Ready™, and Microsoft Hyper-V™ compatible, to provide businesses with powerful and flexible storage solutions for virtualization applications



### Virtualization ready

The Turbo NAS supports VMware Ready™ vSphere 5, VAAI; Citrix Ready XenServer™ 6.0, and is compatible for Microsoft Hyper-V, supporting ODX and Windows Server 2012.

### Secure and flexible storage utilization

The Turbo NAS offers flexible management through creating and allocating iSCSI LUNs (Logical Unit Numbers), mapping and unmapping LUNs to and from the iSCSI targets, and thin provisioning function. The support of CHAP authentication and LUN masking reinforces secured deployment in virtualization applications.

### NAS/iSCSI SAN unified storage

QTS supports NFS and iSCSI SAN storage solution that can be utilized as a network shared storage of the virtualization environments. It helps achieve efficient cost-saving, energy-saving and utilization of storage capacity.



### VAAI for iSCSI, VAAI for NAS

The QNAP NAS, VAAI iSCSI and VAAI NAS are VMware certified. Businesses can either select iSCSI or NFS as a centralized storage to boost performance. VAAI for iSCSI supports Full Copy (hardware-assisted copy), Block Zeroing (hardware-assisted zeroing), Hardware-assisted Locking, and Thin Provisioning with space reclaim. VAAI for NAS supports Full File Clone, Extended Statistics, and Reserve Space. The QNAP NAS uniquely supports VAAI iSCSI and VAAI NAS to enhance storage performance in a virtualized environment.

### Storage for Microsoft Hyper-V

With ODX support, the QNAP Turbo NAS becomes a high performance iSCSI storage solution under Windows Server 2012, including Hyper-V virtualized environment. QNAP storage enables full copies of virtual machines within the NAS without requiring the Windows hosts to read and write the data. This highly reduces the loading of Windows hosts and improves the performance of copy and move operations for Windows 2012 hosts using the QNAP iSCSI storage. When providing QNAP storage to a Windows 2012 file server, the end user using Windows 8 client workstation will also benefit from the Offloaded copy process for large file transfers.

# VM Backup Solution with QNAP and Veeam

Veeam Backup & Replication software combined with QNAP Turbo NAS provides a cost-effective disk-based backup solution for VMware and Hyper-V that maximize data reduction and scales to meet the needs of demanding enterprise environments. This affordable and complete backup solution allows setting up one or multiple Turbo NAS units as the backup storage, replicating VMs and backing them up to a remote site for an efficient disaster recovery solution.

## Solution for VMware

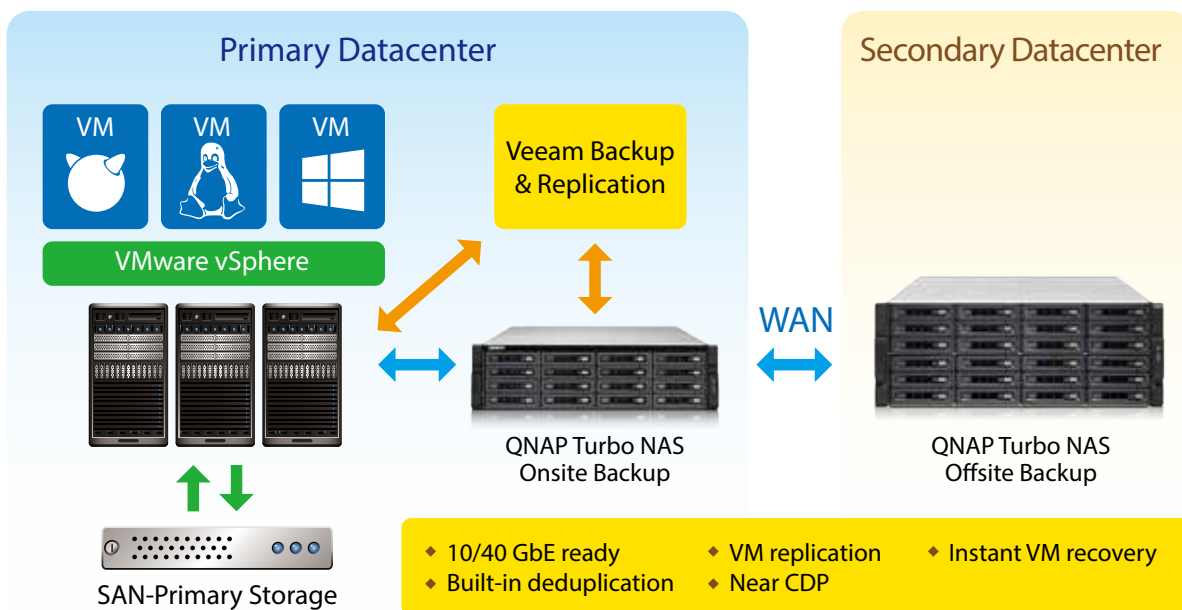

## Solution for Hyper-V

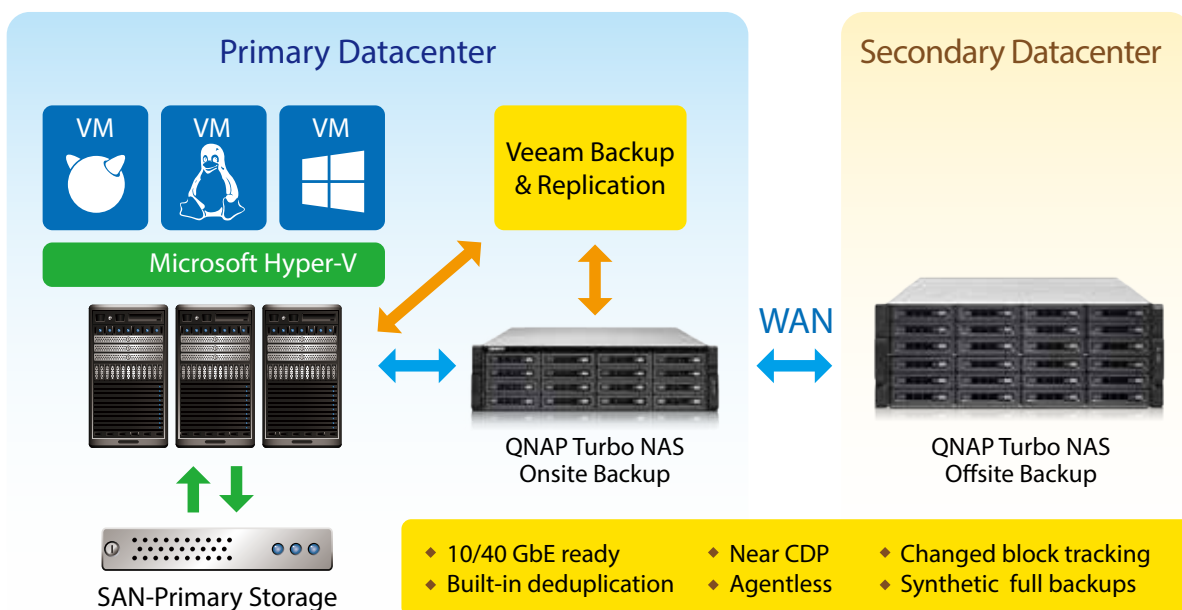

The joint solution of the QNAP Turbo NAS and Veeam Backup & Replication provides complete storage and virtualization environment protection.

## The advantages of using the Turbo NAS with Veeam Backup & Recovery include:

### • High Performance and Efficiency

- 10/40 Gigabit ready: QNAP TS-ECx80U R2 series support 10 and 40 Gigabit interface for a fast transfer rate allowing rapid backup and recovery.
- VMware® and Windows™ Server 2012 Hyper-V support: The Turbo NAS supports both virtualization platforms concurrently. It can be used as the production or backup storage in the virtual environments.
- Large storage capacity: The Turbo NAS supports up to 1216TB of storage capacity (24-bay models). The storage capacity of the server can be expanded by online RAID capacity expansion.
- Built-in deduplication: Save storage capacity with Veeam's built-in compression and deduplication while providing several recovery points for VMs. The Turbo NAS efficiency can be increased, by reducing the required storage space and limiting the data sent over the network.

### • Reliable Data Protection

- RAID data protection: The Turbo NAS provides RAID protection to safeguard backup data from possible hard disk failures.
- Encryption: The Turbo NAS provides an AES-256 volume-based encryption that prevents sensitive data from unauthorized access and data-breach even if the hard drives or the device is stolen.
- Remote Replication: The Turbo NAS provides a real-time or scheduled data replication between a local and a remote QNAP NAS, an FTP server, or an external drive.

### • High Flexibility

- Granular restore: Recover complete VMs, or restore files and folders from inside the VMs using Instant File-Level Recovery (IFLR)
- Veeam Explorer™ for Microsoft Exchange provides instant visibility into Exchange backups, advanced search capabilities, and quick recovery of individual Exchange items (emails, contacts, notes, etc.).
- Instant VM Recovery: Run a Hyper-V or vSphere VM directly from a compressed and deduplicated backup file on the QNAP backup storage, without modifying the backup file. This eliminates the need to extract the backup and copy it to the production storage, reducing the downtime to minutes or less.
- Image-based backups: Speed up the backup process by protecting VMs agentlessly with improved block tracking that delivers fast incremental backups for Hyper-V and vSphere environments. With faster backups, you can protect VMs more frequently, to achieve near-continuous data protection (near-CDP).

### • Good Manageability

- Easy to deploy and maintain: The Turbo NAS can be easily set up and maintained without professional IT knowledge. It can be joined to the Active Directory to allow Veeam Backup & Replication to use the Turbo NAS as the backup destination.
- Notifications via SMS and emails can be set up on the Turbo NAS for instant error or alert notifications.
- Affordable: The Turbo NAS is an affordable network storage solution with enterprise-class server features and performance.
- Eco-friendly design: The Turbo NAS features low power consumption and extremely silent operation.



# QNAP NAS is DataCore Ready

Being certified by the the DataCore Ready Program, QNAP NAS is compliant with DataCore SANsymphony-V software-defined storage infrastructures, and can help organizations maximize the availability and utilization of IT assets and centralize the management of data storage.



## Benefits of using QNAP NAS with DataCore SANsymphony-V

Additional benefits that DataCore provides include simplifying and automating provisioning, uninterrupted access using mirrored nodes, stripping and cache to overcome I/O bottlenecks, automatically optimizing disk access across tiers, and more.

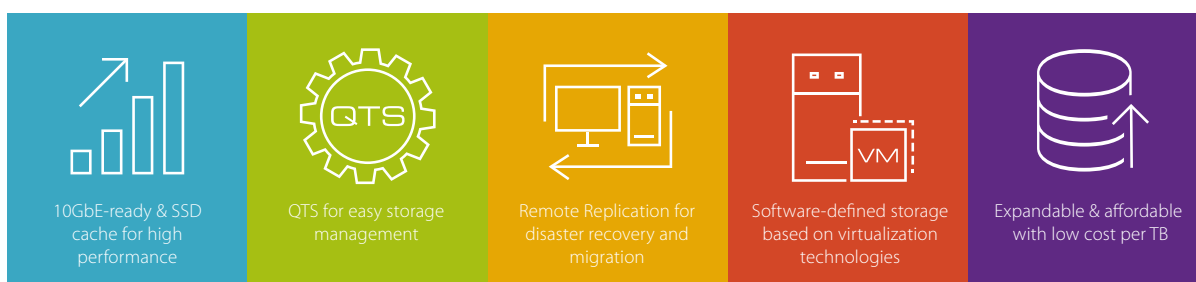

## Easy deployment

QNAP NAS can be easily deployed to ensure storage availability for an organization's production servers and VDI environment.

This solution deployment scenario contains 3 main components:

- Servers in need of storage and high performance, such as virtualization servers, mail servers and/or databases;
- The raw hardware storage with RAID protection and 10GbE capability provided by QNAP;
- DataCore SANsymphony-V that provides virtual storage volumes to the servers coming with high availability.

QNAP NAS provides the raw hardware storage to DataCore SANsymphony-V via iSCSI. Organizations can effortlessly use this joint solution to achieve desired performance levels and functions for file backup/archiving and disaster recovery.

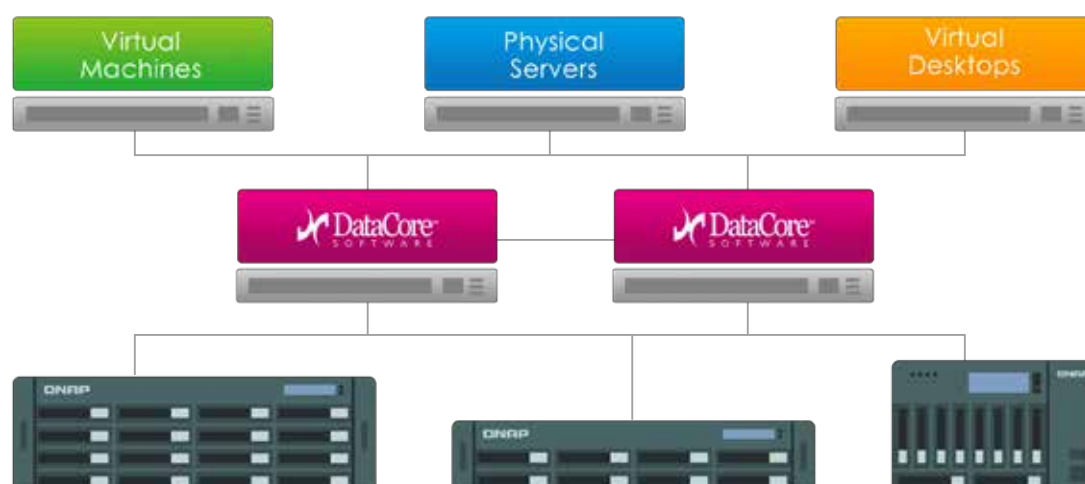

# Productivity tools

## Maximizing the values of your QNAP NAS

QNAP NAS is a versatile device that provides a wide range of features and allows you to share, back up and store multimedia files; manage them using a browser; and stream/play them on HDMI, DLNA, AirPlay and Chromecast devices. You can also download multimedia files to enrich your personal collections.

- **Centralized management**

**myQNAPcloud:** myQNAPcloud Offers an easy-to-use management interface, enabling you to check online information of multiple QNAP NAS. Operating through the browser, you can download, move, copy and share files via QNAP NAS.

**Qsync Central Station 2.0:** Qsync provides you with the unlimited ability to synchronize and share files across multiple devices, free of charge.

**Q'center:** Using the summary charts and other visual reporting tools on the Q'center server, you can easily manage the disk capacity, system health status and more settings on multiple QNAP NAS.

- **Rapid and simple content production**

**Notes Station 2.1:** Quickly compile meeting minutes and marketing reports to share with other users.

**Signage Station:** Easily create and deploy attractive and engaging multimedia signs and ads.

**Qsirch:** With a single keyword, Qsirch can help you locate relevant files or content on a NAS.





## myQNAPcloud 2.0 cloud access service

Helps you easily create your NAS cloud

Cloud access is greatly simplified in QTS 4.2. Following the setup wizard you can effortlessly create your personal or private cloud. With myQNAPcloud 2.0, you can always enjoy the services of your QNAP NAS safely and conveniently.

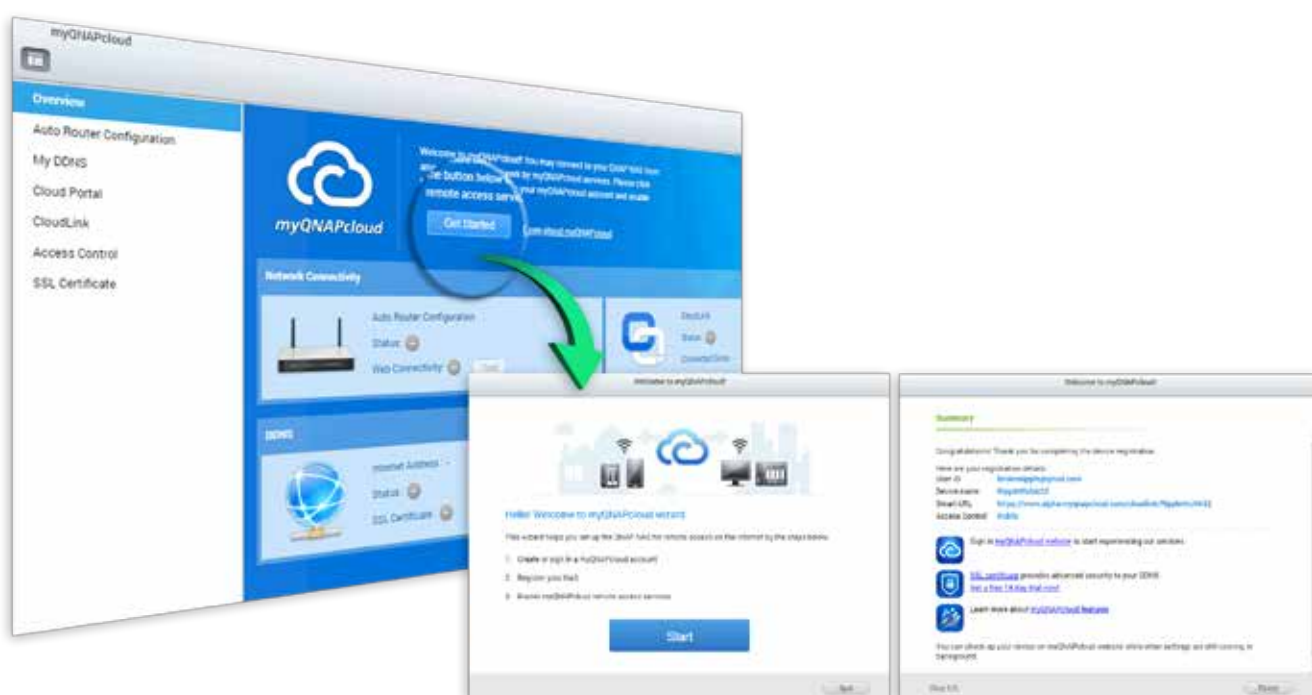

Just follow the wizard's instructions to set up the cloud access.

### myQNAPcloud ID (QID)

Access your QNAP NAS by signing into your myQNAPcloud portal ([www.myqnapcloud.com](http://www.myqnapcloud.com)), mobile Apps, or the PC utility Qsync with "QID", a unique ID for you to access your NAS and securely share your private data and files. When you start the myQNAPcloud App in QTS 4.2 for the first time, the myQNAPcloud wizard will help you register a QID.

To use the services described in the following page, please first activate the cloud services using the myQNAPcloud wizard.



## Manage files and multiple NAS devices with your web browser

The myQNAPcloud web portal ([www.myqnapcloud.com](http://www.myqnapcloud.com)) is a user-friendly interface that allows you to check available and connected NAS servers. You can download, move, copy and share files stored on your NAS servers with your web browser and enjoy the convenience of accessing multiple NAS servers from a central Internet portal.

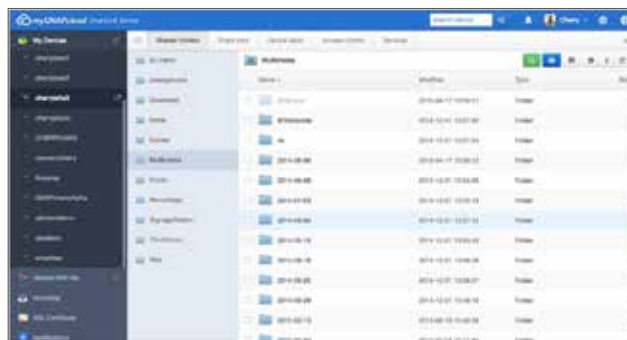

## CloudLink

CloudLink is the best remote access service provided by myQNAPcloud and allows you to connect to your device via the Internet using the myQNAPcloud website ([www.myqnapcloud.com](http://www.myqnapcloud.com)). No complicated port forwarding settings on the router are required: just sign in using your myQNAPcloud ID (QID). Then, you can access files from the myQNAPcloud website. CloudLink will automatically select the best connection for you according to your network environment. In addition to the web-based connection, CloudLink also allows you to connect to your QNAP device with the QNAP mobile apps Qfile and Qmanager as well as the PC utility Qsync. CloudLink greatly simplifies remote connectivity.



## QID access control

To enhance remote access flexibility, you can set access privileges of published services in myQNAPcloud in QTS 4.2 or the myQNAPcloud website:

**Public:** Everyone can search for your device on myQNAPcloud website and access your public services.

**Private:** Only you can access your QNAP NAS remotely on myQNAPcloud website or with mobile apps via CloudLink service.

**Customized:** You can specify who is allowed to access your device on myQNAPcloud website or with mobile apps by entering their registered accounts here. Or you can add the email addresses of your friends who are not currently members of myQNAPcloud to send them an automated invitation message.

## Secured data storage and access

myQNAPcloud supports SSL 2048-bit online encryption to strengthen data security during transmission, ensuring your peace of mind.

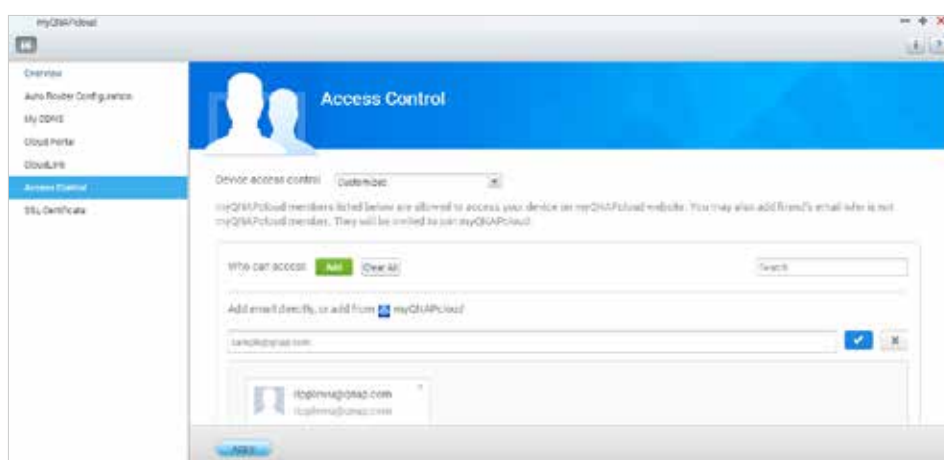

## Supports myQNAPcloud SSL authentication

myQNAPcloud SSL certificates are used to provide a secured connection between the QNAP NAS and web browsers, providing authorization as well as encrypting the connection to secure data and transactions.

- Why do I need myQNAPcloud SSL authentication

When not using myQNAPcloud SSL authentication and linking using HTTPS to a QNAP NAS (i.e. <https://xxx.myqnapcloud.com>), the browser will display a security alert. You will not be able to ensure that the NAS you are trying to connect to is genuine, and you run risks of potentially having the data that you are transmitting being.

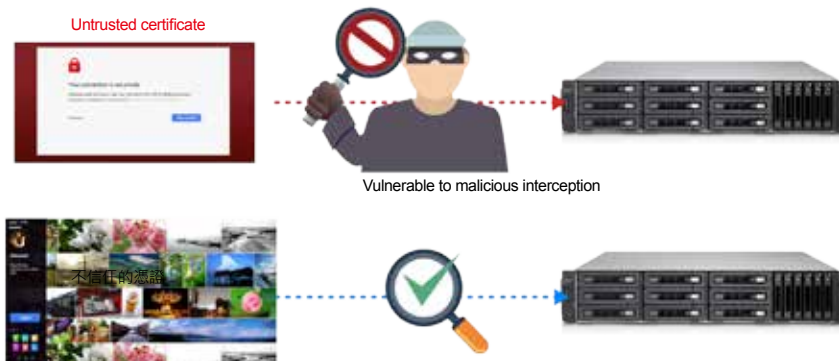

Upon purchasing and installing a myQNAPcloud SSL certificate, you will be able to ensure that the web page you are connecting to is genuine when using DDNS to access a QNAP NAS.



Please go to the myQNAPcloud website and log in using myQNAPcloud ID to purchase it, where the QTS installation authentication is on this webpage.  
myQNAPcloud SSL authentication is only available when used with QTS 4.2.0 or newer version.





# Qsync Central Station 2.0

A private cloud solution combining centralized management and shared folder synchronization

Large volumes of data are transmitted and used by businesses and between departments on a daily basis. While public cloud services like Dropbox can fulfill easy sync and sharing needs, their low data allowances and potential security and ownership issues can leave a lot to be desired. With Qsync, QNAP provides a complete file sync solution that allows businesses and organizations to ensure that team members always have the most up-to-date files for greater working efficiency.



## Synchronization as a better file management and collaboration approach



Qsync Central Station 2.0 supports file synchronization between multiple devices, and you can utilize a smart phone, tablet, computer or webpage to browse through synchronized files. When your computer is offline, you can edit the files offline or view the files on the local Qsync folder, and as soon as the network resumes, online, it will continue to synchronize the data. You can also choose to keep the files stored on your QNAP NAS undeleted to save the storage space of your local device.

## Enhance management efficiency by monitoring equipment settings

The administrator can create default settings on Qsync Central Station 2.0 and also apply them to Qsync clients, which helps to not only save time and effort setting up individual clients, but also allows administrators to monitor user settings, thereby strengthening enterprise-wide IT management and file filtering control and avoiding the risk of deleting files on a QNAP NAS by mistake due to synchronization. Also, by using permission settings, administrators can flexibly adjust individual user's equipment settings, where it not only retains the above advantages, but further enhances the flexibility and convenience of the centralized management approach.

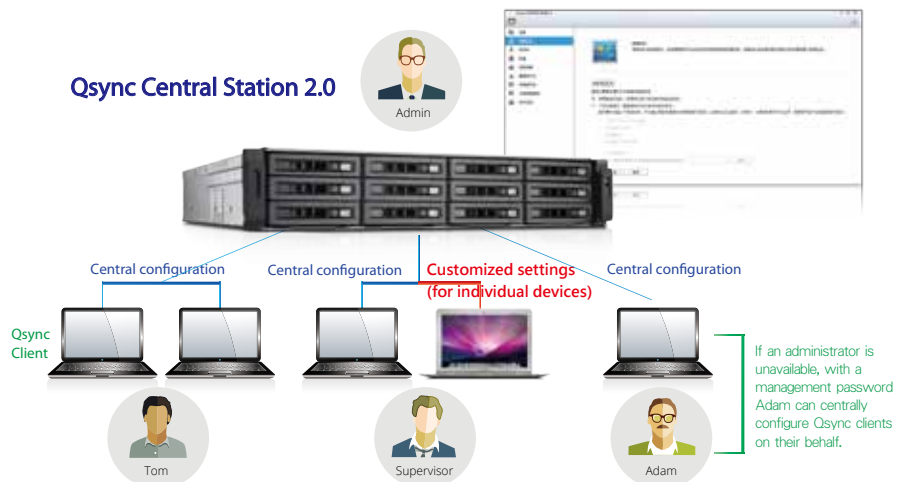

## Supports shared folder synchronization and seamless file sharing for each other

Besides the Qsync folder, now you can synchronize shared folders on a QNAP NAS to the Qsync client on your computer, enabling synchronization among multiple shared folders on the NAS and elevating the level of file sync and sharing efficiency to a higher level.



## Share team folders to improve collaborative and teamwork efficiency

Qsync Central Station 2.0 supports sharing team folders to improve work efficiency, making teamwork simple and easier. Deploying the private cloud synchronization solution on the intranet can help to ensure security of data storage, and the Version Control feature of the shared folder can effectively solve file conflicts or accidental deletion.

## Remotely delete shared folders to prevent data leaks



In the event where a computer/device is stolen or lost, the Qsync folder can be remotely erased\* to ensure that sensitive or confidential data is not accessed by unauthorized users or leaked. Once the computer/device is recovered, Qsync can easily restore the data that was deleted, ensuring the perfect balance between security and convenience.

\* The data will still be retained on the QNAP NAS.

## Advanced system database and algorithms for enhancing system performance

On QTS 4.2.0, a brand-new database system and refined algorithms are incorporated into Qsync Central Station 2.0 to greatly improve the overall system performance and reduce the burden on the NAS and computers/devices using it. When accessed by a single user, Qsync Central Station 2.0's upload efficiency nearly doubles. With 20 users, the upload efficiency further increases by nearly 20 times. All the improvement can maximize collaborative efficiency while minimizing the wait time for the team.

100% | 20x  
Single user | Multiple users

## An array of user settings to choose from

Qsync Client's easy-to-use interface is very user-friendly and comes with a number of handy and practical features (i.e. sharing files through the computer's mail server, connection test, help center.) With Qsync Client, snapping all tasks becomes a piece of cake.

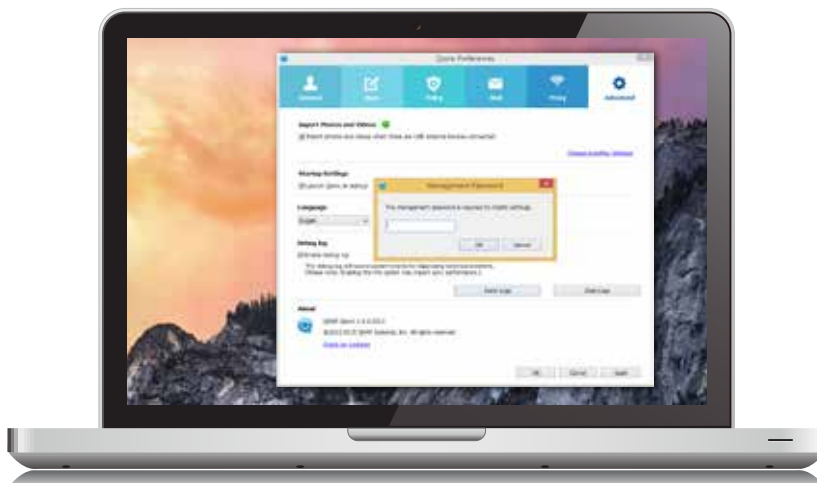



# Notes Station 2.1

A handy notepad on your private cloud

QNAP has leveraged its private cloud functionalities to introduce Notes Station 2.1. It provides the convenience of notetaking on cloud-based services but with the privacy and security of QNAP NAS. Users do not have to worry about risks from public storage, and are able to enjoy easier data access at all times.

## Single workspace for all notetaking activity

With its 3-level structure (Notebooks, Sections, and Notes), Notes Station 2.1 allows you to manage all your notes systematically and flexibly whether it is a note you write to yourself or for work. You can jot your valuable ideas in Notes Station 2.1 and keep them safely accessible through your own devices wherever you are.

## Powerful editing

Notes Station 2.1 is capable of advanced editing. You can style the text by changing the size, font, or color. You can also edit inserted images with the built-in photo editor to enrich your content.



## Diverse backup styles

Notes Station 2.1 offers several backup options. Users can choose to back up files to their PC or NAS. Additionally, system administrators can use the backup features of the NAS to periodically and remotely replicate everyone's notes.

	Notes Station 1.0	Notes Station 2.1
Snapshots for version control		v
Notebook backup	v	v
Full backup		v
NAS to NAS backup		v

- Notebook backup: A user can choose to back up his or her notebook.
- Full backup: This feature is for administrators only. Administrators can back up notebooks for all users of the NAS.
- NAS to NAS backup: Administrators can back up notebooks to a different NAS for all users.

## Google Calendar Support

he event in the Notes Station Calendar links to the note you created it from. You can update the calendar from Notes Station 2.1 to your Google Calendar with a single click, so you will be reminded for every event.



The events on your Notes Station Calendar

## Protect notes with military-grade encryption

Notes Station 2.1 can secure your notes using the highly-efficient AES 256-bit encryption specification. By encrypting your notes, you can rest easy knowing that only authorized users can access confidential and sensitive information.



## Import & export PDF and epub files

Notes Station allows you to directly import contents (such as comic books, eBooks and scholarly articles) from PDF or epub files to assist in putting information together before editing, commenting and marking. Existing notes on the Notes Station can also be exported as PDF or epub files for backup and sharing.



Some imported files may not be displayed as their original layout.

## Preview attached files

You can directly preview inserted documents (including PDF, Word, and PowerPoint files) on Google Docs and Office Online, and even play inserted multimedia files with the built-in media player without needing to download any files.



## Subscribe to RSS live feeds

Notes Station 2.1 includes RSS support that helps gather subscribed online content from websites and blogs. All of the latest RSS contents are effortlessly centralized on the Notes Station for easy note-taking.



## Restore notes to a previous version

Notes Station 2.1 features snapshots for version control, which can be used to retain different versions of notes at different time points. You can easily restore a note to a previous version whenever needed without worrying about frequent changes to notes.



## Share notes for teamwork

Notes Station 2.1 is helpful for communication and teamwork in work and life. You can create sharing links to share your notes via social networks and messenger apps on mobile devices, or invite other users to read and edit notes for productive communication and teamwork.



## Back up content from Evernote

Notes Station 2.1 supports backing up your notes from Evernote, allowing you to directly import them from Evernote's public cloud to the secure private cloud provided by your QNAP NAS. You can further edit these imported notes with Notes Station's powerful editing tools and easily share with others.







# Qsirch v2.1

Search for everything on your QNAP NAS

A QNAP NAS is a converged storage solution required to store huge volumes of data and provide users with the tools and utilities to make use of that data. The first utility users need is the ability to find their data. Qsirch is designed to simplify and accelerate searching for files on a QNAP NAS. Finding your files couldn't be easier.



## QNAP exclusive, smarter search engine

Qsirch uses fine-grained indexing conditions in combination with its full-text search capabilities to support searching over 6,000 file types. Powered by TF-IDF algorithm and a near real-time search engine, the Qsirch enables users to search while typing and sort through files faster and more precisely

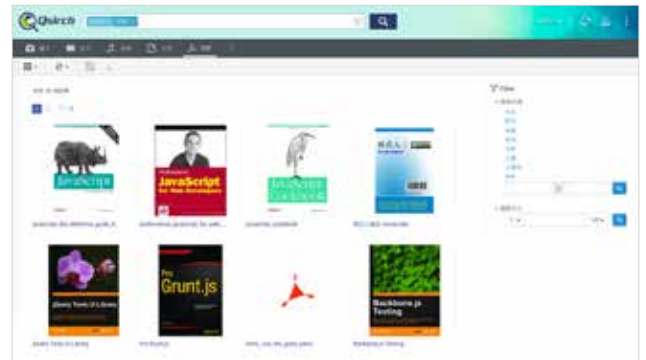

## Qsirch browser add-on for Google Chrome

Install the Qsirch add-on to enable Qsirch from your web browser. Simply click on the Qsirch icon on the right of the address bar to search Google and your QNAP NAS simultaneously. Your Qsirch and Google search results will appear side-by-side for space-saving, time-saving convenient comparison.



- Simultaneous search on Google®



## Presentation by file types

Search results can be filtered and presented by types including photos, music, videos, and documents. This visualization enables you to locate your desired results faster. In addition to sorting by file type, results can be organized based on criteria such as modified dates, file sizes, etc.



## Content Preview

Thumbnail previews for photo, videos, and PDFs makes searching and browsing through voluminous data a lot faster, while the Gmail preview function enables you to preview emails and your Gmail backup files easily and quickly.



## Advanced indexing technology

Indexing runs as a background task, enabling you to oversee the indexing progress and current status. This feature can also be used to exclude files from indexing.



## Saved searches for even faster results

Records of every search are kept, and users can even search through these records and store frequently-used search criteria.



## Share directly from your search results

Use the direct sharing function in Qsirch 2.1 to share from your search results instantly.



QTS 4.2.0 or later versions is required for Qsirch 2.1 and the sharing function of Qsirch is only available on QTS 4.2.1.



# Surveillance Station 5.1

Build a professional surveillance system

QNAP Surveillance Station 5.1 is a professional network surveillance video management system. One of the QNAP NAS flagship applications, Surveillance Station turns your NAS into a professional Network Video Recorder (NVR) that can be operated from a PC, mobile device, or with an HDMI® local display. Supporting real-time monitoring, recording, playback, alarm notifications, Intelligent Video Analytics (IVA), and management, Surveillance Station safeguards your assets and property when used with supported IP cameras. Every QNAP NAS comes with a minimum of 2 free camera channels as standard, is ONVIF® compliant, and compatible with over 100 camera brands (and more than 3000 camera channels,) allowing you to easily build a professional video recording and monitoring system.

camera licenses  
**free : 8**  
 up to : 80

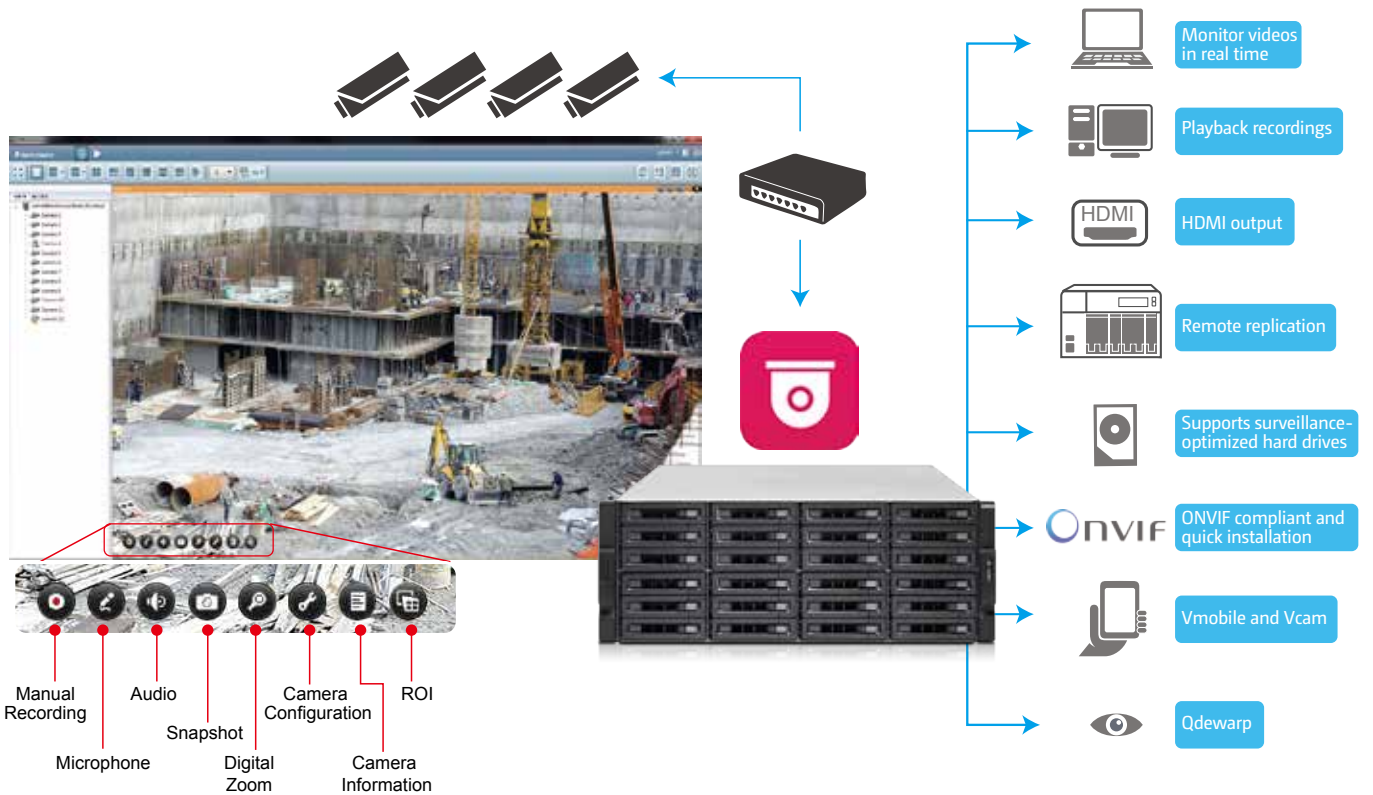

Before using Surveillance Station, please install the Surveillance Station App from the App Center. For a list of compatible cameras, please refer to [www.qnap.com](http://www.qnap.com).

## Tiered Storage for Hybrid NAS and NVR Operations

Empowered with a tiered storage architecture, QTS can now separately store NAS and NVR data in different storage pools that consist of dedicated hard drives. Additionally, you can designate dedicated network ports for NVR or NAS traffic to achieve the best data write/read performance.

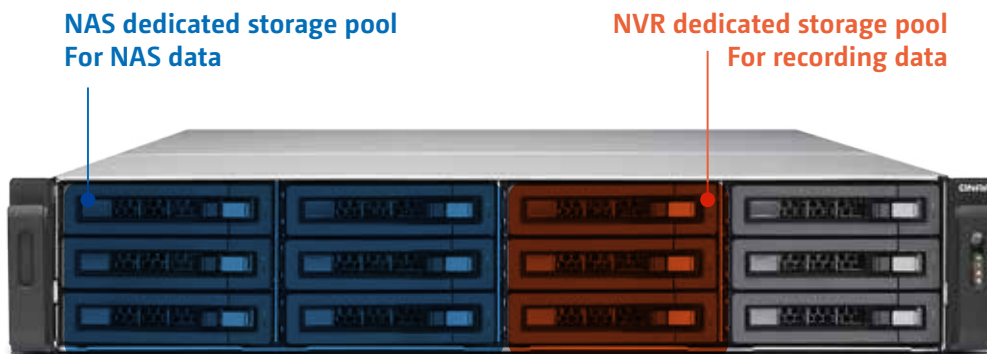

## Set Dedicated Storage Pools for NVR

Using Storage Manager, it is possible to set dedicated storage pools for Surveillance Station to isolate disk arrays to ensure that NAS and NVR operations are separate.

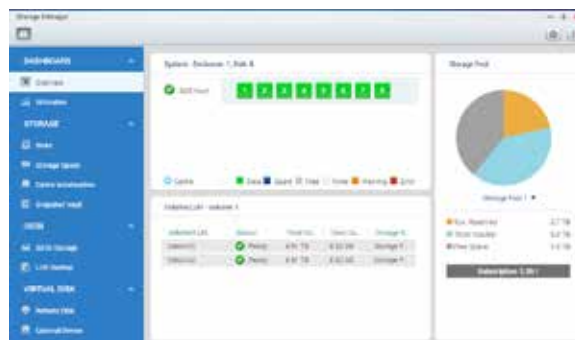

## Network Tap

In addition to tiered storage, QNAP have also added a “network tap” capability to Surveillance Station. Activate this function on a QNAP NAS with more than one network port and easily reroute the monitoring network flow to other QNAP NAS network ports, optimizing the read/write performance for NAS and NVR traffic.

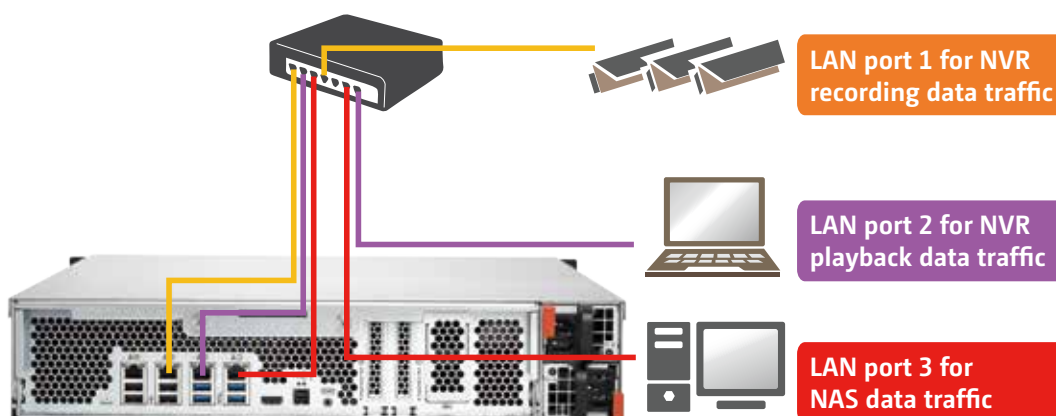

## Quickly Build a Professional Surveillance System in 3 Easy Steps

### 1. Choose where Surveillance Station recordings are saved.

During the initial setup of Surveillance Station, designate a location to save Surveillance Station recordings. QNAP advises a dedicated storage pool for recordings.

 We recommend using hard drives specifically designed for NVR/surveillance purposes. Please refer to [www.qnap.com](http://www.qnap.com) for the compatibility list.

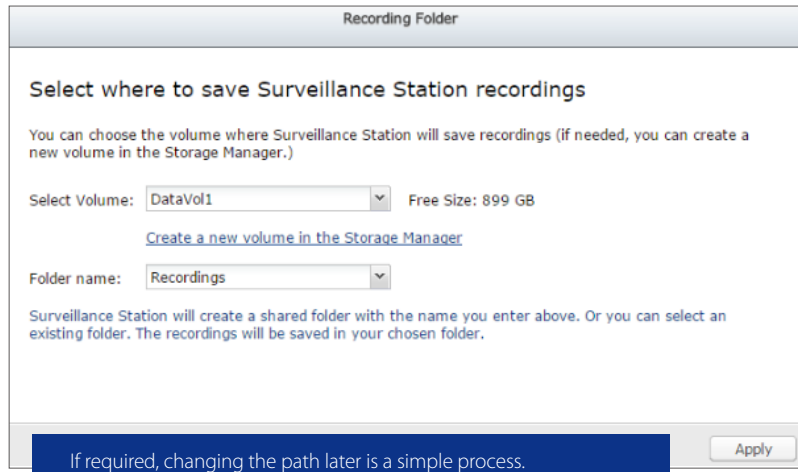

### 2. Set up the cameras

Complete the camera installation and confirm the cameras are on the same LAN, click "Add" and Surveillance Station will search for available cameras.

 In addition to IP cameras, USB cameras are supported by installing the QUSBCam app. Using USB cameras is an inexpensive way to extend surveillance coverage offering a huge array of camera form factors for suitable for a wide array of deployment scenarios.

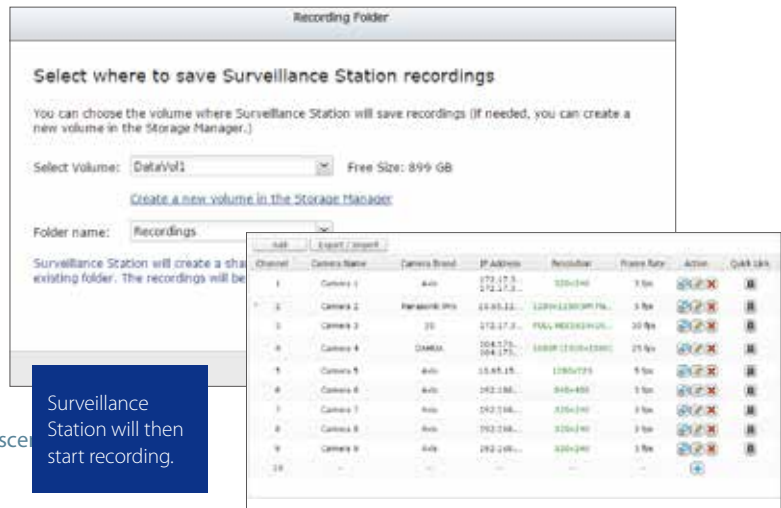

### 3. Start monitoring or playback.

There are several ways to playback recordings or to monitor cameras with QNAP surveillance solutions. Click "Playback" or "Monitor" in Surveillance Station, or use the Vmobile App or QvPC to monitor the camera feeds.

 For NAS models with an HDMI® port and memory larger than 4GB, QvPC Surveillance Station (Local Display) can display monitored camera feeds on Smart TVs.

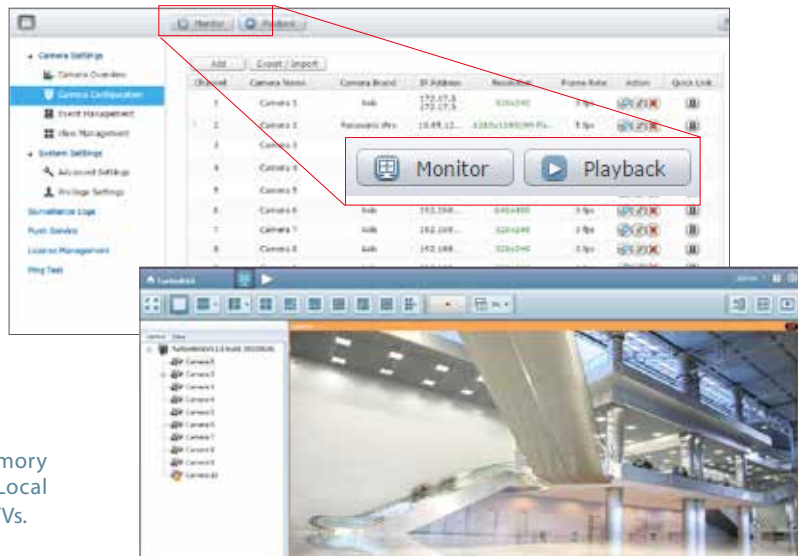

 If you are using a PC or Mac, please install the client utility first. Click "Monitor" or "Playback" and the wizard will show up to guide you through the installation process. Clients are able to log into different surveillance stations to monitor their subset of cameras.







## Virtual camera

Very high-resolution cameras often lose details in playback display of huge coverage areas, presenting a problem for surveillance users. Using virtual camera technology, users are able to focus on defined sub-areas within the area captured. Virtual cameras do not require additional licenses, making them ideal for deployment in areas requiring expansive coverage.

 The support of digital watermarking assists in verifying the authenticity of exported videos and snapshots by showing the exact recording date & time, camera name, and QNAP NAS model name, making it essential when videos are needed as verifiable evidence.

## Qdewarp and ROI

### QNAP Qdewarp

Fisheye lenses are ideal for wide-angle scenes. With de-warping technology, users are able view detailed images without distortion. Qdewarp is compatible with every fisheye camera that QNAP supports, and enables users to de-warp images at any time point in a recording. Qdewarp supports real-time monitoring and recording playback, ensuring there are no blind spots.

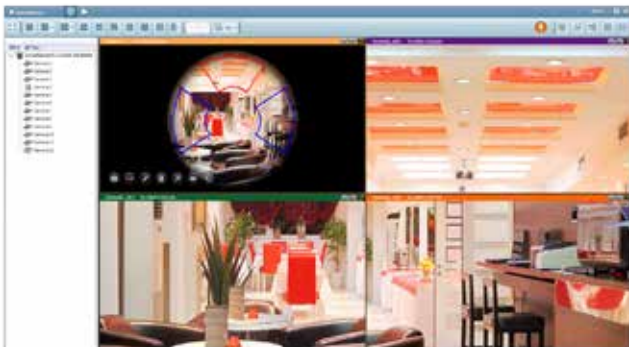

## PTZ control (Pan/Tilt/Zoom)

Directly adjust the vertical tilt, left/right panning angles, and zoom on cameras with compatible PTZ (Pan/Tilt/Zoom) functions. The "Click Go" PTZ control feature greatly enhances the convenience of remote surveillance.

### Region of Interest

The 4K era is upon us and a huge number of cameras on the market now support 4K HD images. The ROI function is excellent for high definition cameras and enables users to freely enlarge, adjust, or move the region of interest on any recording channel. Surveillance Station 5.1 retains ROI settings for each session so it is ready at the next log in.



## Immediate alerts for events

### Set alert and notifications

When cameras detect motion or alerts are triggered, Surveillance Station will automatically send notifications to up to 5 email addresses.

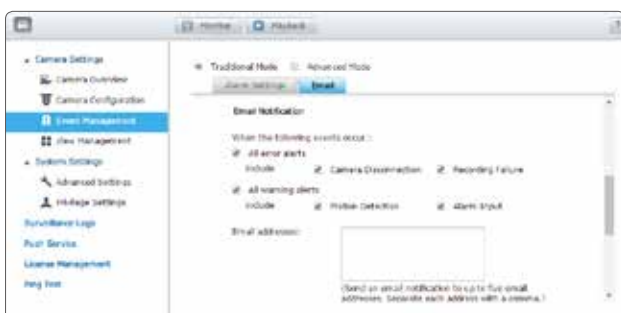

### Digital floor plan for camera locations

Uploading a floor plan to Surveillance Station enables users to map out where cameras are located. Based on alarm settings, the camera icons will then alert users to assist in decision making for appropriate action to be taken.





# App Center

Customize your QNAP NAS for endless possibilities

Extend the functionality of your QNAP NAS to enrich your work and home life. QTS App Center provides various install-on-demand apps for you to enjoy more applications and to increase the total value of the NAS.



## Powerful and, rich-in-content

The App Center provides more than 100 add-on apps, including backup/ sync, business, content management, communications, developer tools, download, entertainment, surveillance and utilities.

## 1-click Install on demand

Find what you need and install it immediately with just one click.

## Upgrade reminder

Once your installed apps have upgrade version, an upgrade reminder will show on the QTS desktop to help keep your NAS applications up-to-date.



# Gamil Backup 1.3

A hassle-free way to back up data on PC

The QNAP Gmail Backup app provides Gmail backup and recovery functionality, allowing users to search and organize archived emails and their attachments.

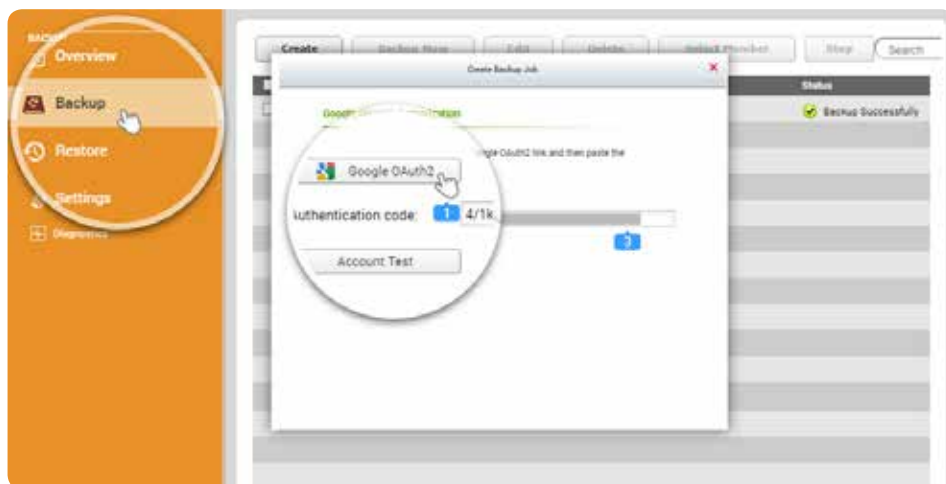

## Complete email backup

Gmail Backup supports Oauth 2 authentication for individual and domain account email backup and migration. The application can be configured with a dedicated folder for each backup task for single or domain accounts, assisting users in quickly backing up, searching and managing their emails.

## Efficient Gmail recovery

If emails are mistakenly deleted, the recovery function can restore them to their original email account without needing additional tools. Users can also choose to restore a specific email or all emails from an account.

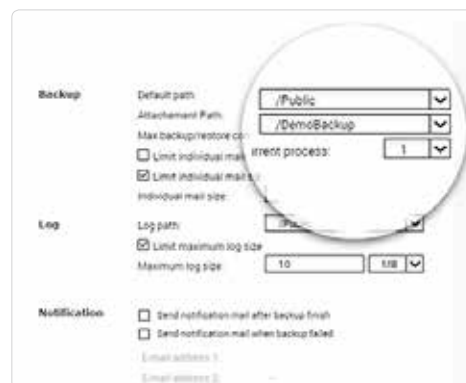

## Separately access and search attachments from an email

Back up attachments to a separate backup folder for better organization of archived data.

## Complete operation logging

Gmail Backup is capable of logging all of the activities and backup status for users to view their backup process in detail.

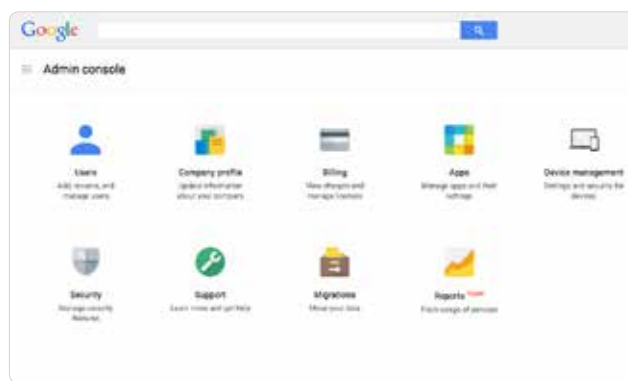



# QTS with Integrated Linux

The perfect development platform

QNAP has employed advanced virtualization technologies to seamlessly integrate Linux with QTS, enabling you to use QTS while simultaneously using the Linux system on an HDMI display. Expand the functionalities of your NAS with the QTS App Center, and exploit the incredibly popular open source Linux Operating System to leverage your NAS as a complete development platform.

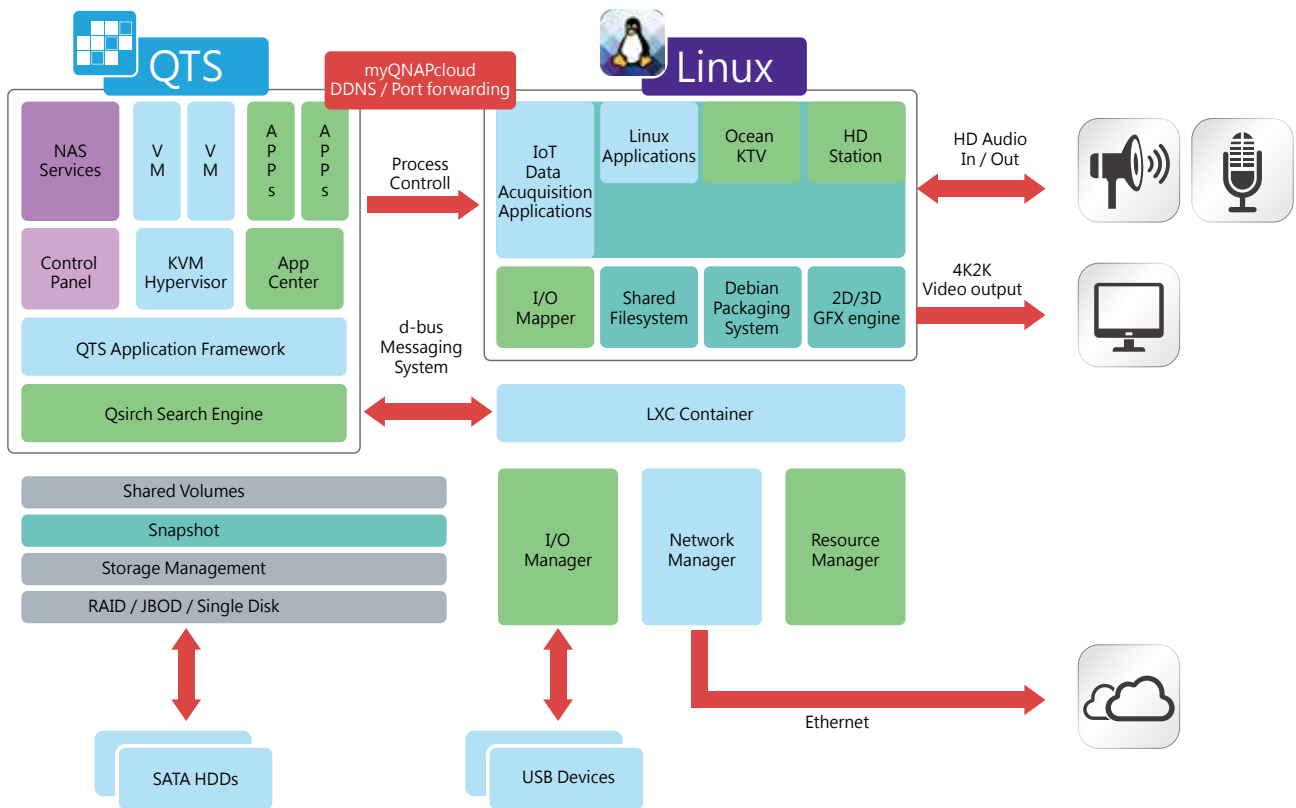

## The all-new open source Linux Station – Keeps you ahead of IoT

The TS-ECx80U R2 introduces the all-new Linux Station, enabling you to display the Linux desktop on an HDMI external monitor. Simply connect a keyboard and mouse to the TS-ECx80U R2 and use your NAS as a PC. Use Linux Station to switch the output resolution freely or enable remote desktop connection to send the display to a web browser.



Please upgrade to version 4.2.1 to enjoy Linux Station.

Install Linux Station from the QTS App Center. Remote Desktop does not currently support audio output.



## Seamlessly switch between HD Station and Linux

Select to output HD Station using either the simple or the advanced mode. Go to [Control Panel] > [Apps] > [HybridDesk Station] to set the current display mode and switch the output on your HDMI display.

### HD Station simple mode

Enjoy the multitude of supported apps, such as Kodi®, HD Player, YouTube®, JRiver®, and many more via a simple and intuitive interface. Use your NAS as a multimedia player and use your smart phone, an infrared remote control, or connect a keyboard or mouse for completely convenient playback and control. HD Station V3 supports HDMI for a local display such as a TV. The local display ensures output of media files without the need for a network connection for a better and more stable viewing experience.

### Linux Station advanced mode

Install various applications on the Linux Station, an open-source platform. Customize a 3D desktop with thousands of desktop themes to choose from. It operates just like a PC.

## HD Station V3 - Use your QNAP NAS as a home theatre system

Simply plug in an HDMI monitor to your NAS, and you can start playing media files from the NAS. This avoids complicated settings of network media players and instability of network conditions, allowing you to have a better viewing experience with large-screen TVs.

### Qremote - Easy to get started

Qremote is QNAP's exclusive remote control enabling you to control your HD Station from your mobile devices. Qremote offers four modes: application shortcuts, simple remote control, touch screen, or keyboard mode to enter text. Use your smart phone or other mobile device to download the Qremote App from the App Store or Google Play® Store.



### Multilingual input and improved multitasking

HD Station V3 supports multi-lingual input, enabling you to search from a web browser in your native language. Additionally, HD Station V3 now supports multitasking with a desktop PC-like taskbar enabling you to switch between different applications.

### A wealth of apps

In addition to QNAP's native applications, the NAS supports a number of common multimedia players (Kodi, HD Player, Plex Home Theater®, DeaDBeeF, Clementine®, JRiver®), browser (Chrome, Firefox), and other multimedia streaming platforms (YouTube®, Spotify®, TuneIn Radio®) to provide you with home cinema entertainment.

## JRiver® Media Center - Powerful media management and lossless audio playback in HD Station V3

JRiver Media Center is a jukebox style multimedia player capable of managing several large media libraries within the same domain. JRiver® Media Center supports a variety of multimedia streaming formats and multi-room streaming, and is capable of indexing album covers for a variety of metadata to provide efficient multimedia management. Additionally, JRiver® Media Center also supports a number of professional music processing features such as an equalizer, rhythm, pitch, and sampling rate to further meet the needs of video enthusiasts and significantly enhance your QNAP NAS multimedia streaming experience. For more information, please refer <http://www.jriver.com/>





## Custom Remote – Use your existing IR remote controls with HD Station

HD Station supports remote control learning enabling you to use your existing IR remote controls with HD Station. Matching your existing remote control with HD Station only requires two steps, and helps reduce clutter in your living room.

Enter "Settings">"Preferences" in HD Station. Find "Custom Remote" and select a slot for the new remote control.



Follow the on-screen instructions and press and the button you want to match. Hold the button until the progress bar is complete.

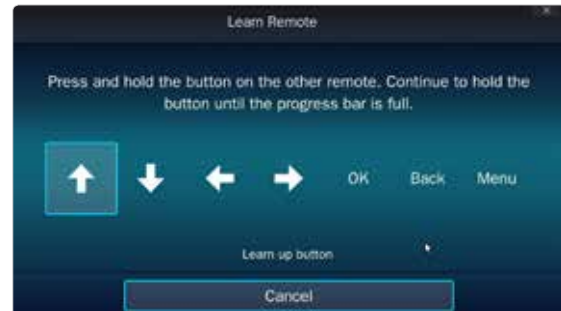

### System requirements

- ◆ HD Station 3.1.1 or later
- ◆ Supports up to 3 simultaneous custom remote controls
- ◆ Some IR remote controllers are not supported

## Limitless IoT possibilities - instantly start your open source projects

The explosive popularity of IoT related application means our lives and devices are increasingly linked across the Internet, creating potential privacy pitfalls. QNAP NAS provides the best private cloud solutions with an all-new AES encryption engine capable of encrypting a specific folder or an entire storage volume. QTS also supports AES encryption of external USB/eSATA drives to protect against unauthorized access.



### Intelligent dog tag DOTT

Recognizing that there are more than 10 million pets lost each year, a development team from Los Angeles designed a smart dog tag. DOTT enables pet owners to better monitor and keep track of their pets. DOTT can provide valuable information via instant push notifications in the event a dog ventures too far away from home or gets lost in an unfamiliar environment.

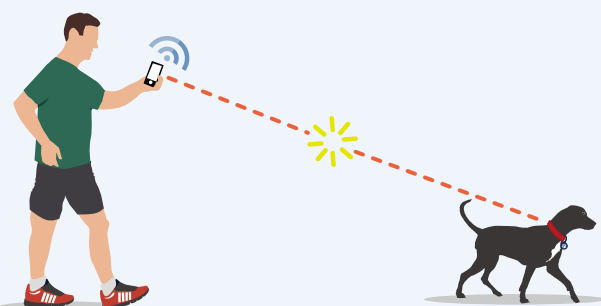

### Fitbit® fitness bracelet

Fitbit's fitness products help you to stay motivated and improve your health by tracking your activity, exercise, food, weight, and sleep with activity trackers or wireless-enabled wearable devices. View progress and analyze your trends with easy-to-read charts and graphs to empower and inspire you to live a healthier, more active life. Embrace the Fitbit community with your friends to share stats, and compete on the leaderboard.





# Photo Station 5

Record the precious moments in your life

QTS Photo Station helps you archive, easily manage, and share your precious memories. The Photo Station functions as your private photo hub while safeguarding your memories with the very highest levels of protection.

## Switch between Gallery and Management

Switch between Gallery and Management mode to view and organize your photos easily. Photo Station provides three quick configuration menus to adjust the look and feel of how your photos are displayed.



Switch between display modes, and select the photos to display.



Customize the background music in gallery mode. The background music can be chosen from playlists in the Music Station.



Play your selected photos in a slideshow.

## Centrally manage all your pictures on your NAS

Whether you upload your photos directly, or by synchronizing with the Qsync utility, using Photo Station to manage your photos (including very high-resolution photos) from multiple sources is a very effective way to organize massive volumes of photos.

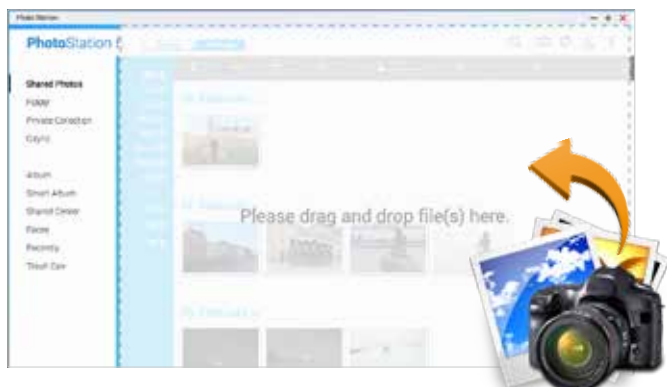

## Create photo albums and smart albums

Create a virtual album and add photos to the album without moving the physical files. Alternatively, create a smart album that automatically searches and adds photos that match the search criteria such as Today in history, a specific period, or tags. Creating a smart album with a specific period is an easy way to keep a record of your travels.

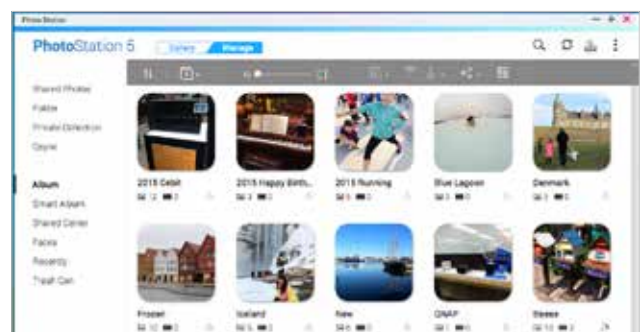



## Video Station 2.3

Entertainment beyond the limits of devices and languages

Video Station is your personal entertainment library that can organize and play your videos providing greater convenience in searching for covers and subtitles online; and streaming via DLNA, Airplay, and Chromecast.



### Dedicated video website

Video Station features an excellent platform for you to create your personal video website. All of the videos on the QNAP NAS can get categorized by Video Station and converted into different resolutions and universal formats for smooth viewing across any network bandwidth or any device.

### Easy video categorizing

You can set up video categories including movie, TV series, home video, and music video then create smart collections in terms of category, label, ratings, and more. The smart collection folder will gather similar videos for better management and to make it easier and faster to find videos you want to watch.

### Community website interaction

It's easy to share videos with Video Station. Share your exclusive videos via email; on social networks like Facebook, Google+, and Twitter; or give sharing links to friends and relatives. Best of all, you can bind a Facebook account to share your collections with friends without them needing to have an account on your NAS.



# Mobile Apps & Utilities

Conveniently access your QNAP NAS with mobile devices

In the digital age, mobile devices have become a popular choice for Internet and NAS access. For various mobile user scenarios, QNAP has introduced a list of mobile Apps to help users access their NAS with their mobile phone.

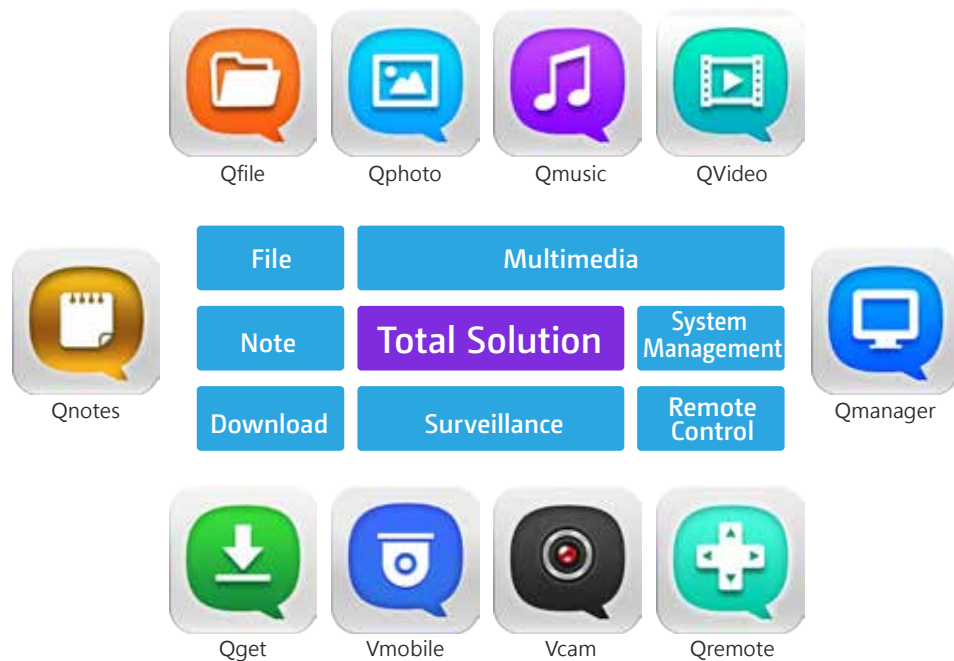

## Automatically update photos from your smart phones in your trip

In your trip, photos on your mobile device can be automatically uploaded to your NAS, allowing you to focus on your photos instead of worrying about running out of space.

## Easily share large files with friends and families

Sharing huge files is extremely easy with QNAP mobile apps. Share them whenever and wherever you want.

## Browse files stored on your NAS

Access your multimedia (photos, videos and music) and office documents (Word, PDF, or Excel) stored on your NAS using your mobile phone.

## Manage services on your NAS with ease

Check the status of your NAS or enable/disable NAS application services remotely using your phone.







## Qfile 2.0

Access files stored on your NAS remotely using a mobile device

Supports iOS (iPhone and iPad), Android devices (phone and tablet), and Window phones.

### Versatile and real-time file management

Remotely upload/download, share, manage and stream files from a QNAP NAS and synchronize between the NAS and your mobile device.

### Remote file access

The file thumbnails help you easily identify file types at a glance, allowing you to spot music, videos and photos rapidly.

You can stream multimedia files and play them on your mobile phone, turning it into a mobile media player.

### Efficient storage use for your mobile phone

Download documents to your mobile devices for offline reading, manually or automatically back up photos and music stored on your mobile phone to your QNAP NAS.

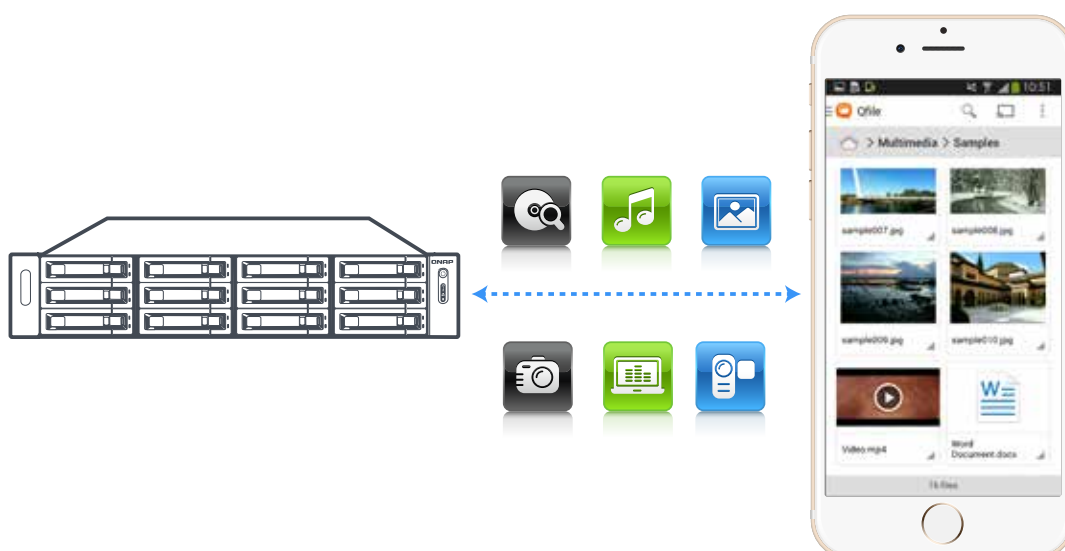

### Folder and file sharing

Create download links for shared folders or files to share via email, SMS or mobile apps, or email the files as attachment.





## Using Qfile

Tap "+" to add a NAS.

Qfile will search for a QNAP NAS on your LAN. Tap on one of the NAS to add it.

Tap "Add NAS manually" if you are not at your home.

Qfile will save your login details after you successfully log in to a NAS the first time, and you don't need to enter login details later.

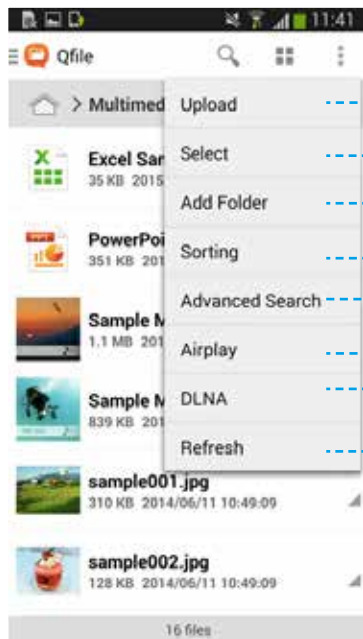
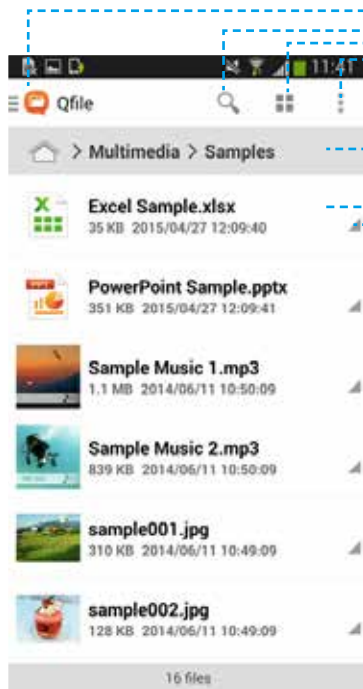
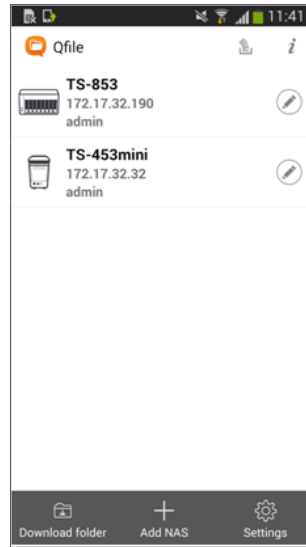

Access files and folders on your NAS after your login.

- 1 Tap to open a file
- 2 File path: Click to quickly change your location
- 3 Switch between shared folders, check background tasks or Qfile settings
- 4 Search files
- 5 Menu and thumbnail modes
- 6 More functions
- 7 Upload files to the NAS and supported upload options: Upload photos from the photo library or camera, upload files from the Qfile download folder, and upload files from the local download folder (this option is only supported for Android devices.)
- 8 Enable multi-select mode
- 9 Add a new folder
- 10 Sort: Sort files by filename, size, modified date or file attribute
- 11 Advanced search: Quickly locate files you are looking for based on file size, modified date, filename or user. The thumbnail preview feature allows you to instantly preview the file in a simpler and intuitive approach.
- 12 Stream multimedia files to Airplay devices
- 13 Stream multimedia files to DLNA devices
- 14 Refresh the current page.
- 15 Show available actions for the selected file.

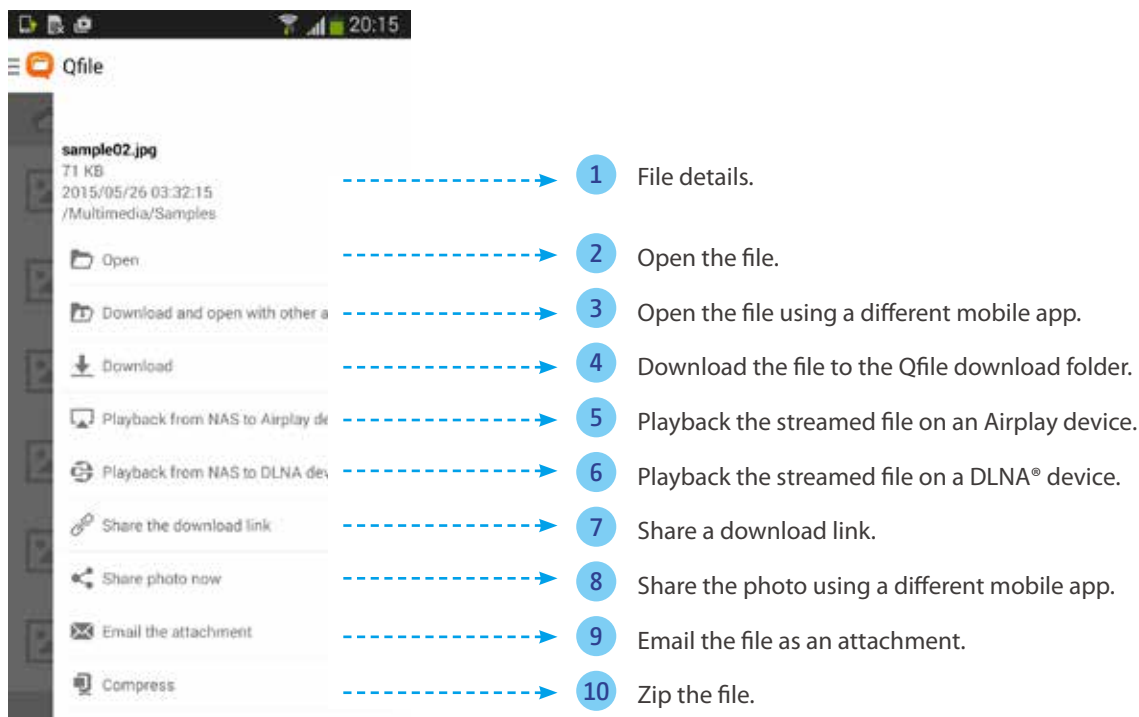

## Three file sharing methods:

1. Directly share photos you are browsing on social networks using apps such as Line or Facebook (as the below figure.)
2. Share files as email attachments.
3. Create download links. To share a huge file, you can create a download link in Qfile and share that download link on social network sites, in an email, or SMS message. The recipient will be able to directly download the shared file using that link you provide.

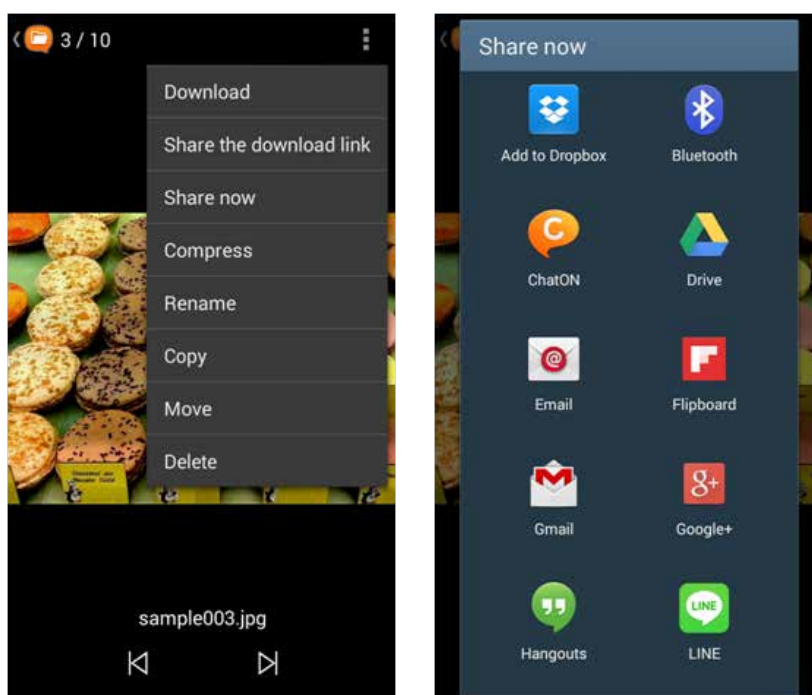



# Qmanager 2.0

Remotely manage and monitor your QNAP NAS

Supports iOS (iPhone and iPad), Android devices (phone and tablet), and Window phones.



## Manage your private cloud

Monitor your system information, check backup tasks and system events and manage services.

## Manage system services

Get up to date about system status. Remotely pause/run backup tasks and enable/disable application services or third-party Apps.

## Manage users and shared folder privileges

Check the user, user group and shared folder status. The intuitive interface helps to improve your management efficiency.

## Manage download/backup tasks

Check the backup task information and run existing backup.

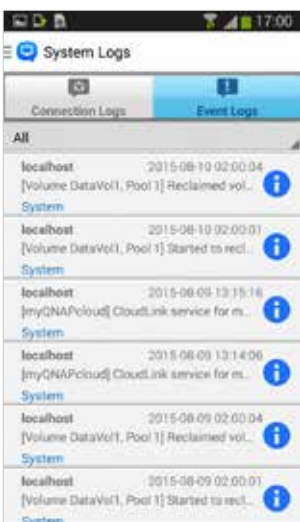

## Monitor system status

Review system and connection records, restart or shutdown your QNAP NAS remotely, identify the location of your NAS, wake up your NAS via WOL, and safely reject external devices.

## Push notification

Check system events and real-time updates and receive important push notifications on your mobile phone.





# Vmobile 2.0

## Professional mobile surveillance App

Supports iOS (iPhone and iPad), Android devices (phone and tablet), and Window phones.

### Mobile surveillance

Access surveillance system to manage and monitor IP cameras anytime, anywhere.

### Profile management

Create multiple profiles with different sets of VioStor NVR/ QNAP NAS and IP cameras, and efficiently switch between different monitoring views from the profile list.

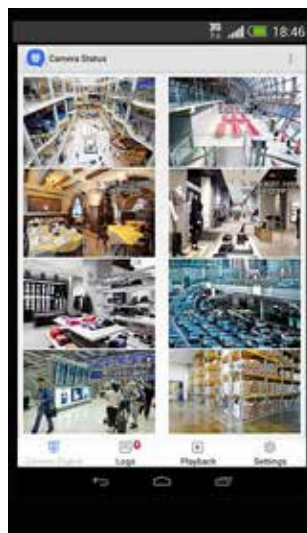

### PTZ control and preset position control

The PTZ (Pan/Tilt/Zoom) cameras can be controlled directly on mobile devices. It's easy to adjust the monitoring angles and preset monitoring position.

### Event notification

When an event occurs, Vmobile can notify by ringtone, push notifications, or vibration to alert you immediately.



### Recording playback

After you receive event notifications, you can tap the event logs to directly play them and to see the incident for yourself.

### Low bandwidth mode

If you have a slow Internet connection, you can select a stream optimized for low bandwidth to provide smoother video playback. The quality of the video recording will not be affected.



### Video playback

Slide on the timeline to conveniently play back recorded videos. You can also choose to play back alarm events only for quick review.

### Quick search by date and time

Search a specific video section by date and time, quickly and precisely.





# Computer Utilities

Boosting your Productivity



## Qfinder Pro

Search, connect and set up your QNAP NAS

Available for Windows, OS X, Linux and Chrome Browser.

Qfinder Pro is a utility to quickly find, access and set up the QNAP NAS over a LAN. Install Qfinder Pro on your computer, open it, and double click your QNAP NAS name, and the login page is ready for you.

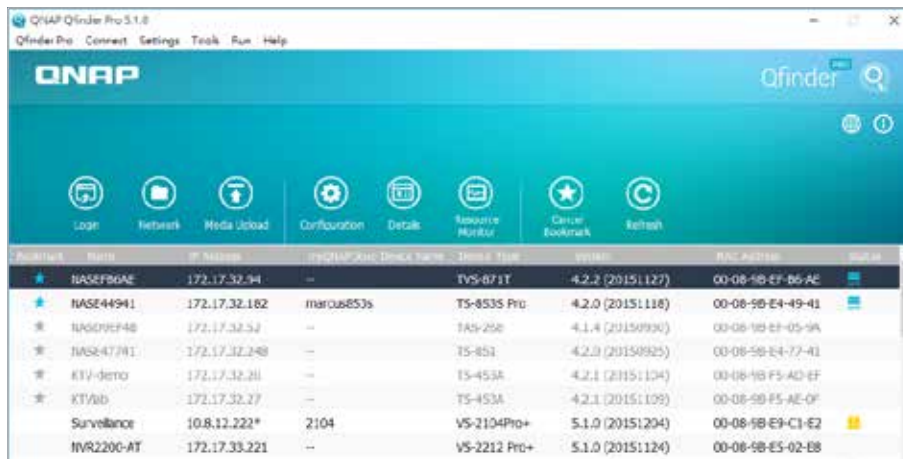

### Easily access the NAS by Storage Plug & Connect

The Windows version of Qfinder Pro provides a convenient way to connect to QNAP NAS and map a network drive or a virtual disk. By creating a shared folder on the QNAP NAS and mapping it as a network drive, you can use it as an additional drive and store files on it as it is a local drive of the computer.

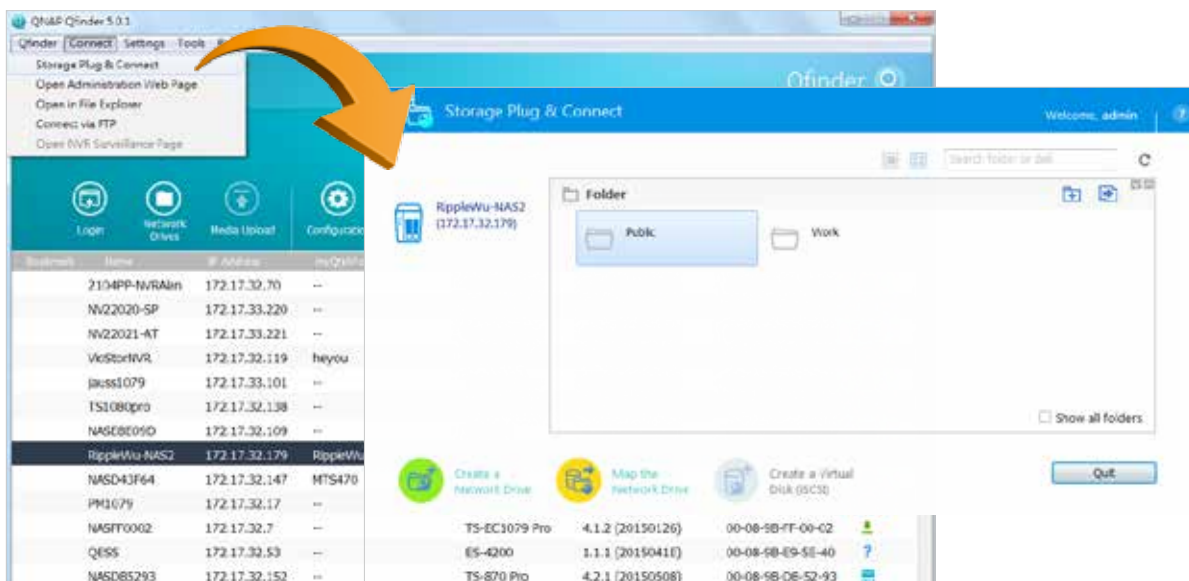





## NetBak Replicator

A hassle-free way to back up data on PC

Available for Windows

The QNAP NetBak Replicator is free for anyone with a QNAP NAS and helps you easily back up files from Windows PC - entire disk drives, documents, pictures, music, videos, fonts, emails, and more - to the QNAP NAS. The operation is very simple. You can set up the backup task in just a few clicks using NetBak Replicator by the setting real-time synchronization, scheduled backup and auto-backup from multiple PCs to the QNAP NAS. NetBak Replicator also supports backing up to a remote server via FTP and WebDAV through the Internet. Imagine that you can backup new photos whenever on vacation. Even you are away from home, the convenient backup supports your memories.



## Qsync

Sync Files Anytime and Everywhere

Available for Windows and OS X.

Qsync is a useful tool to synchronize files across multiple computers and supports Windows and Mac. It creates a specific "Qsync folder" in your devices that you can simply drop files in, and synchronizes the files to all your devices linked to the QNAP NAS. For more information, refer to the Qsync Center Station 2.0 section in this catalog.



## vSphere Client plug-in

Manage QNAP NAS within vSphere Client

Available for Windows.

QNAP NAS supports vSphere Client Plug-in that allows managing VMware datastores on the NAS directly from the vSphere client console. In a large-scale server virtualization environment, management is centralized and straightforward. Administrators can easily control the status of the QNAP NAS and datastores and create additional datastores to multiple ESXi hosts in just a few clicks.

# Hardware Introduction

The Turbo vNAS series is ideal for deployment in the data center for building hybrid cloud storage. This Turbo vNAS series offers advantages in hardware design and reduced price, bringing a breakthrough level of price/performance.

## Intel® Xeon® E3-1246 v3 3.5GHz and Core i3-4150 processors

The TS-ECx80U R2 series is powered by a quad-core Intel® Xeon® E3-1246 v3 or Core i3-4150 processor, providing 12-bay, 16-bay, 24-bay storage capacity. It delivers superior performance with up to 3,500 MB/s throughput & 392,000 IOPS. The mSATA modules can further enhance NAS performance for IOPS-demanding applications.

### TS-EC1280U R2

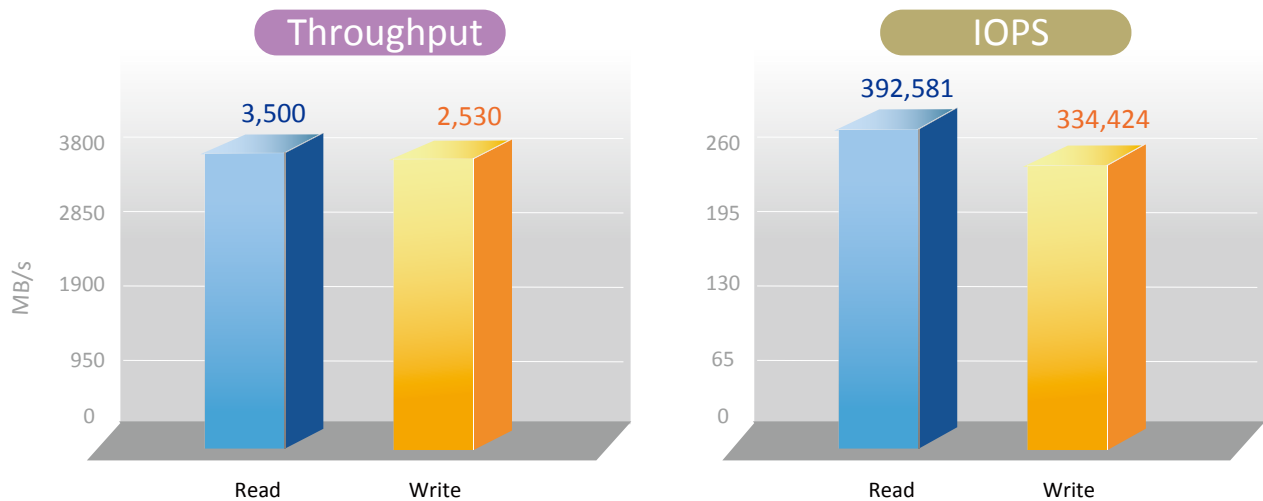

#### Test Environment:

2 Client PC: Intel® Core™ i7-2600 CPU, 16GB DDR3 RAM, Windows 7 professional 64-bit, Dual-port Intel X520 10GbE Server Adapter, IOMeter  
 Test Environment : 4 Client PC configurations: Intel® Core™ i7-2600 CPU, 16GB DDR3 RAM, Windows 7 professional 64-bit, Dual-port Intel X520 10GbE Server Adapter, IOMeter sequential read and write. NAS Configuration : OCZ Vertex4 VTX4-25SAT3-128G SSDs with RAID 6 configuration, QNAP LAN-10G2T-U dual-port 10GBase-T network adapter\*2

## SSD cache acceleration

The TS-ECx80U R2 series supports SSD caching options (including two internal mSATA modules) to improve the overall workflow of IOPS-demanding applications such as virtualization and data center deployment. The SSD caching can be easily utilized and managed with the QTS Storage Manager. The SSD cache adopts the Read Cache with Write Through algorithm and can greatly improve random read performance and ensure data security.



# Built-in 10GbE and 40GbE Ready

## QNAP and Mellanox provide the most cost-effective compute and storage Ethernet Interconnect Solution

TS-ECx80U R2 with ConnectX3 Pro hardware offload engines to Overlay Networks ("Tunneling"), provide the highest performing and most flexible interconnect solution for PCI Express Gen3 servers used in public and private clouds, enterprise data centers, and high performance computing.

Public and private cloud clustered databases, parallel processing, transactional services, and high-performance embedded I/O applications will achieve significant performance improvements resulting in reduced completion time and lower cost per operation.



### Highest Throughput

scalable bandwidth with 10/40/56 GbE per Port

### Lowest Latency

end-to-end latency <1us

### Virtualization

eSwitch and SR-IOV to improve VM performance

### Overlay Networks

hardware offload of VXLAN/NVGRE to reduce CPU overhead

### RDMA over Ethernet

RoCE to accelerate application execution

### Data Center Bridging

future proofs the network

### Convergence

hardware based isolation, security and QoS

### Virtual Protocol Interconnect

VPI enables seamless operation over any converged network

LAN-10G2SF-MLX Dual SFP+  
LAN-40G2SF-MLX Dual QSFP+



## Building a fast storage network is the WAY TO GO

- ◆ 56GbE for storage network, 40GbE to the existing network
- ◆ Improved isolation (much easier to troubleshoot)
- ◆ Low latency (core switches are slow, typically store & forward)

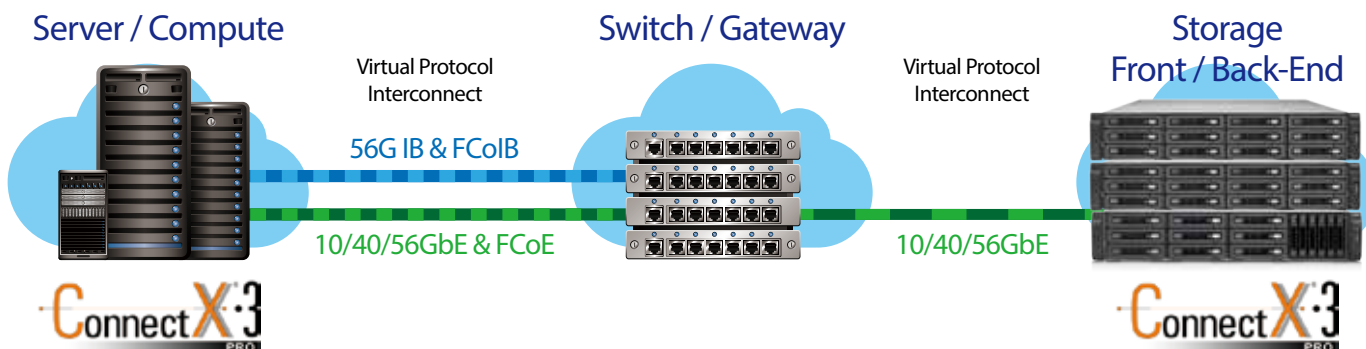

# 10GbE/40GbE Application

## 10GbE/40GbE NAS Solution

A 10GbE/40GbE (10 Gigabit/ 40 Gigabit Ethernet) network is essential for businesses that demand high bandwidth for virtualization and fast backup and restore for an ever-growing amount of data. QNAP's 10GbE Turbo NAS series is an affordable and reliable storage solution for deploying a 10GbE environment

## Virtualization Solution

### Powerful storage solution for virtualized data center:

Application and processing requirements constantly evolve heightening the need for higher performance storage. Especially with virtualization of IT resources the need for high performance storage is essential. The Turbo NAS offers class leading hardware matched with unparalleled 10Gbps/40Gbps speed for all the virtualization needs.

The 10Gbps/40Gbps speed will increase the agility of data transmission in a virtualized environment intensifying NFS and iSCSI connection performance.

Benefits of QNAP 10GbE/40GbE ready Turbo NAS:

- Leverage all the benefits from virtualization technology
- Deploy the virtualization environment with flexibility
- Improve work continuity

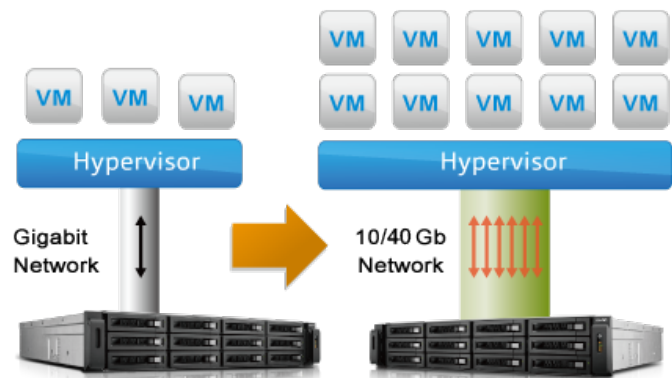

## Video Editing Solution

### QNAP 10GbE/40GbE ready NAS is a good alternative solution of DAS for video studio

Digital film and video production produces volumes of data that require high performance RAID storage with sustainable throughput to balance with the demanding output of video editing. The Turbo NAS fulfills storage and video editing needs with a high-speed 10GbE network interface. Digital videos can be quickly stored and edited on the Turbo NAS directly over the network.

The Turbo NAS supports various network file sharing protocols such as NFS, AFP, and SMB/CIFS, so sharing files among PCs with different operating system is easy. The scalable design of the Turbo NAS allows for the capacity to be expanded on the fly so the Turbo NAS can grow as the business data does.

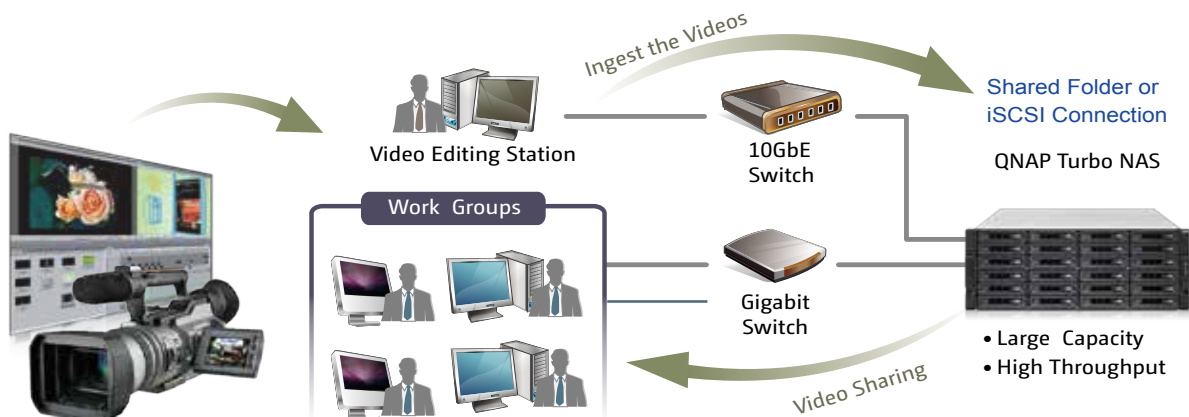

# QNAP 12Gbps SAS JBOD Expansion Enclosure

SME (small and medium-sized enterprises) usually will not acquire all storage assets at once. Instead, they need a flexible storage system which provides high scalability and capability of agile data migration to efficiently handle the unpredictable and explosive growth of storage in business-critical environments.

## ➤ QNAP scale-up solutions

With QTS storage management coupled with the scale-up solution, businesses can balance the costs and benefits when deploying storage systems for big data storage.

QNAP Turbo NAS business series supports QNAP RAID expansion enclosures to expand the total storage of over 700TB raw capacity\*.

The RAID expansion enclosures support Missing Mode protection to well protect the data.



Available maximum raw capacity is varied by NAS models.

## ➤ QNAP 12Gbps SAS Expansion Enclosure

The QNAP REXP-1220/1620 expansion enclosure is designed for expanding the storage space on a Turbo NAS by connecting multiple expansion enclosures via high-speed mini SAS cables. This is especially useful for large data applications, such as video surveillance, data archiving, and TV broadcast storage. Featuring a 12 Gbps SAS interface on the chassis, the REXP-1220/1620 ensures fast data passthrough from 12 Gbps SAS-enabled Turbo NAS even when using 6Gbps hard drives.

## ➤ Plug and use

Simply connect a REXP-x20 expansion enclosure to a Turbo NAS and power it on. The Turbo NAS will detect the hard drives in the REXP-x20 as newly installed local drives. The Turbo NAS capacity can be expanded seamlessly by using the powerful QTS Storage Manager.

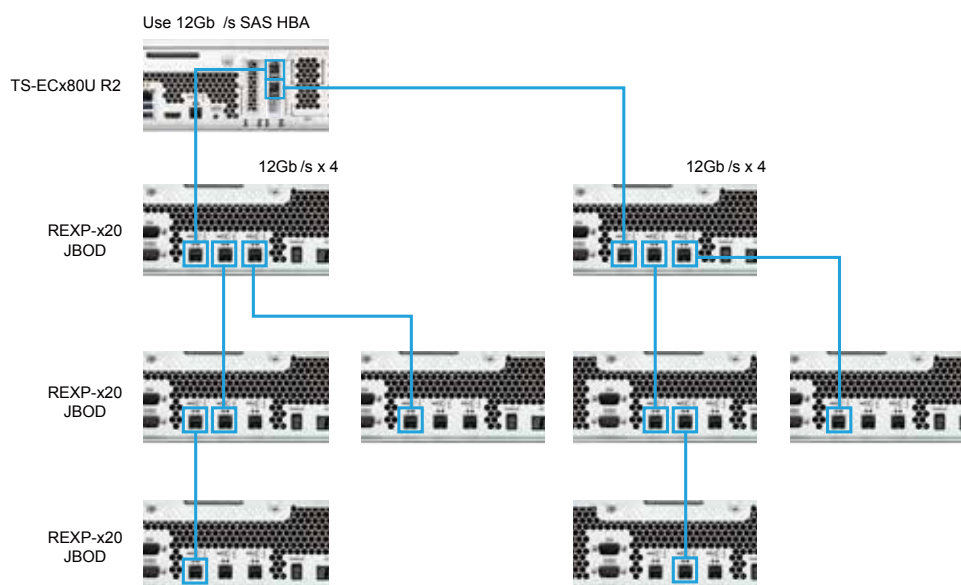

\* SAS HBA card (SAS-12G2E-U) is required



## Seamless capacity expansion

The TS-ECx80U R2 series supports online capacity expansion by cascading multiple QNAP RAID expansion enclosures to meet the needs of growing business data. With the QNAP scale-up solution, total storage capacity can be gradually expanded on demand. It is especially useful for large data applications, such as video surveillance, data archiving, and TV broadcast storage

## Missing mode protection

When the disconnection of a RAID expansion enclosure is detected, the Turbo NAS blocks IO access to protect data. The system can recover from the missing mode to the normal state with data staying intact.



## Flexible drive type and capacity



SAS/SATA  
2.5"/3.5"



SSD

The REXP-1620/1220 offers high flexibility in hard drive selection. IT administrators can choose enterprise-level SAS HDDs with high performance and high reliability for mission-critical applications, low-cost but high-capacity SATA HDDs for large data archiving, or high-speed and high stability SSDs for I/O-intensive operations.

The maximum raw storage capacity available by connecting QNAP expansion enclosures:

Turbo NAS Model	TS-EC880U R2	TS-EC1280U R2	TS-EC1680U R2	TS-EC2480U R2
Maximum number of connected REXP-1620U-RP	8	8	8	8
Maximum number of hard drives	136	140	144	152
Max. Raw Capacity	1088 TB	1120 TB	1152 TB	1216 TB



The maximum capacity is calculated by using 8 TB 3.5" HDDs & 1 TB 2.5" HDDs.

# Hardware specification

## TS-ECx80U R2 Series



Model	TS-EC2480U-E3-4GE-R2	TS-EC1680U-E3-4GE-R2	TS-EC1280U-E3-4GE-R2	TS-EC880U-E3-4GE-R2
	TS-EC2480U-i3-4GE-R2	TS-EC1680U-i3-4GE-R2	TS-EC1280U-i3-4GE-R2	TS-EC880U-i3-4GE-R2
	TS-EC2480U-i3-8G-R2	TS-EC1680U-i3-8G-R2	TS-EC1280U-i3-8G-R2	TS-EC880U-i3-8G-R2
CPU	For E3 models: Intel® Xeon E3 Quad-core processor For i3 models: Intel® Core i3-4150 processor			
Memory	Total memory slots: 4 For 4GE SKUs: 4GB DDR3 ECC RAM For 8G SKUs: 8GB DDR3 non-ECC RAM			
Drive	24 x 3.5" / 2.5"	16 x 3.5" / 2.5"	12 x 3.5" / 2.5"	8 x 3.5" / 2.5"
Drive Type	SATA 6Gb/s & 3Gb/s, hot swappable			
LAN Port	Built-in 2 x 10 GbE (SFP+) and 4 x GbE 40GbE is optional			
PCI-E Slot	2 (one is occupied by a Dual-port 10GbE network adapter)			
HDMI / USB 3.0 / USB 2.0	1 / 4 / 4			
Users / Groups / Shared Folders	4096 / 512 / 512			
Max Concurrent Connections (CIFS)	1500			
Max IP Cameras	Default 8 / Max 80 (optional)			
QNAP Expansion Enclosure	Max 8 REXP-1620U-RP/ REXP-1220U-RP			
SSD Cache	✓			
Hardware Transcoding	✓			
Virtualization Station	✓			

\* Design and specifications are subject to change without notice.

## JBOD Hardware specification



Model	REXP-1620U-RP	REXP-1220U-RP
Form Factor	3U rack mount	2U rack mount
Host Interface	Three SAS 12Gbps wide port	
LED Indicators	Front panel: Status, fault, system over heat, fan error Rear panel: SAS link, SAS error, enclosure ID	
Dimensions (DxWxH) mm	130 x 442.4 x 528.3	88 x 439 x 520
Weight (Net/ Gross) kg	18.14 kg/25.92 lb	14.8 kg / 21.18 kg
Max. number of HDDs/SSDs supported	16	12
Hard Drive Type	3.5" SAS/SATA 12/6Gb/s, SAS/SATA 3Gb/s hard drive or 2.5" SAS/SATA SSD	
Temperature	0-40°C	
Humidity	5~95% RH non-condensing, wet bulb: 27°C.	
Power Supply Specification	Redundant/ Hot Swap ATX Power Supply, 650W, 90-240Vac~, 50-60Hz	Redundant/ Hot Swap ATX Power Supply, 400W, 90-264Vac~, 47-63Hz
Management	Managed via QNAP QTS OS 1. Supports disk S.M.A.R.T. information 2. RAID expansion enclosure identifier 3. Locate RAID expansion enclosures 4. Locate hard disks on RAID expansion enclosure 5. Smart fan control by detecting system and hard drive temperature 6. In-band SAS firmware update	

Design and specifications are subject to change without notice.

## Accessory

Category	Order P/N	Description
SAS Card	SAS-12G2E-U	Dual-wide-port storage expansion card, SAS 12Gbps
Rail kit	RAIL-A03-57	A03 series (Chassis) rail kit, max. load 57 kg
	RAIL-A02-70	A02 series (chassis) rail kit, max. load 90kg(For TS-EC2480U R2 only)
mSATA Flash	FLASH-256GB-MSATA	128GB mSATA Flash module x 2
RAM	RAM-4GDR3-LD-1600	4GB DDR3 RAM, 1600MHz, Long-DIMM
	RAM-4GDR3EC-LD-1600	4GB DDR3-1600 ECC Long-DIMM RAM Module
Cable	CAB-SAS10M-8644	MiniSAS external (SFF-8644 to SFF-8644), 1.0m
	CAB-SAS05M-8644	MiniSAS external (SFF-8644 to SFF-8644), 0.5m

All specifications are subject to change without notice. For more information, please go to [www.qnap.com](http://www.qnap.com)

## Network card compatibility list

Category	Order P/N	Interface	Description
QNAP	LAN-10G2T-U	10GBASE-T	Dual-port 10 Gigabit network expansion card for rack mount model, low-profile bracket, cat6A cable
	LAN-10G25F-MLX	SFP+ OPTIC	Dual-port 10 Gigabit network adapter
	LAN-40G25F-MLX	QSFP+	Dual Port QSFP+ 40 Gigabit network adapter
Mellanox	MCX311A-XCCT	SFP+ DAC/Optic	ConnectX®-3 Pro 10 Gigabit Ethernet Single SFP+ Port Adapter Card, full high bracket
	MCX312B-XCCT	SFP+ DAC/Optic	ConnectX®-3 Pro 10 Gigabit Ethernet Dual SFP+ Port Adapter Card, full high bracket
	MCX313A-BCCT	QSFP+	ConnectX®-3 Pro 40 Gigabit Ethernet Single QSFP+ Port Adapter Card, full high bracket
	MCX314A-BCCT	QSFP+	ConnectX®-3 Pro 40 Gigabit Ethernet Dual QSFP+ Port Adapter Card, full high bracket
Intel	X520-T2 (E10G42BT)	10GBASE-T	Dual-port 10 Gigabit network expansion card for tower models, desktop bracket, cat6A cable
	X520-SR2 (10G42BFSR)	SFP+ OPTIC	Dual-port 10 Gigabit network adapter, short range optical cable
	X520-DA2 (E10G42BTDA)	SFP+ DAC (Direct Attach Copper)	Dual port 10 Gigabit network adapter, SFP+ direct attach copper cable
Emulex	Oce11102-NT	10GBASE-T	Dual-port 10 Gigabit network expansion card for rackmount models, cat6A cable
	Oce11102-NM	SFP+ OPTIC	Dual-port 10 Gigabit network adapter, short range optical cable
	Oce11102-IM	SFP+ OPTIC	Dual-port 10 Gigabit network adapter, short range optical cable
	Oce11102-NX	SFP+ DAC (Direct Attach Copper)	Dual port 10 Gigabit network adapter, SFP+ direct attach copper cable
	Oce11102-IX	SFP+ DAC (Direct Attach Copper)	Dual port 10 Gigabit network adapter, SFP+ direct attach copper cable

# Software specification

## Operating System

- QTS 4.2 (embedded Linux)

## Supported Clients

- Windows 7 (32/64-bit), Windows 8 (32/64-bit), Windows Server 2003/2008 R2/2012/2012R2
- Apple Mac OS X
- Linux & UNIX

## Supported Browsers

- Google Chrome
- Microsoft Internet Explorer 10+
- Mozilla Firefox 8+
- Apple Safari

## Multilingual Support

- Chinese (Traditional & Simplified), Czech, Danish, Dutch, English, Finnish, French, German, Greek, Hungarian, Italian, Japanese, Korean, Norwegian, Polish, Portuguese (Brazil), Romanian, Russian, Spanish, Swedish, Thai, Turkish

## File System

- Internal Hard Drive: EXT4
- External Hard Drive: EXT3, EXT4, NTFS, FAT32, HFS+

## Networking

- TCP/IP (IPv4 & IPv6: Dual Stack)
- Quad Gigabit NICs with jumbo frame (failover, multi-IP settings, port trunking/NIC teaming)
- Service binding based on network interfaces
- Squid Proxy server
- Proxy client
- DHCP client, DHCP server
- Protocols: CIFS/SMB, AFP (v3.3), NFS(v3), FTP, FTPS, SFTP, TFTP, HTTP(S), Telnet, SSH, iSCSI, SNMP, SMTP, and SMSC
- UPnP & Bonjour Discovery

## Security

- Network access protection with auto-blocking: SSH, Telnet, HTTP(S), FTP, CIFS/SMB, AFP
  - CIFS host access control for shared folders
  - FIPS 140-2 validated AES 256-bit volume-based data encryption\*
  - AES 256-bit external drive encryption\*
  - Importable SSL certificates
  - Instant alert via E-mail, SMS, beep, push service, and LCD panel\*\*
  - 2-step verification
- \* SomeThe data encryption functions may not available in accordance with the legislative restrictions of some countries.

## Storage Management

- QNAP flexible Volume/LUN with thin provisioning and space reclaim
- RAID 0,1, 5, 6, 10, + hot spare
- Supports storage pool\*
- Support snapshot (4GB System RAM required)\*
  - Support Volume/LUN snapshot\*
  - Snapshot manager\*
  - Snapshot clone\*
  - Snapshot vault\*
  - Snapshot replica\*
- Snapshot Agent for Windows VSS and VMware\*
- Online volume expansion
- Online storage pool expansion
- Online RAID capacity expansion and online RAID level migration
- SMART data migration
- Storage expansion
- JBOD enclosure roaming
- SSD read-only/read-write cache
- Bad block scan and hard drive S.M.A.R.T.
- Bad block recovery
- RAID recovery
- Bitmap support

## Power Management

- Wake on LAN
- Internal hard drive standby mode
- Scheduled power on/off
- Automatic power on after power recovery
- USB and network UPS support with SNMP management

## Access Right Management

- Batch users creation
- Import/export users
- User quota management
- Local user access control for CIFS, AFP, FTP, and WebDAV
- Application access control for Photo Station, Music Station, Video Station, and Multimedia Station
- Subfolder permissions support for CIFS/SMB, AFP, FTP, and File Station

## myQNAPcloud Service

- Private cloud storage and sharing with myQNAPcloud id (QID)
- Free host name registration (DDNS)

- Auto router (via UPnP) configuration
- Web-based file manager with HTTPS 2048-bit encryption
- Cloudlink for remote access without complicated router setup
- myQNAPcloud connect for easy VPN connection (Windows VPN utility)

## Qsync

- Syncs files among multiple devices with SSL support
- Selective synchronization for syncing specific folders only
- Share team folder as a file center for team collaboration (Maximum sync tasks: 32)
- Shares files by links via email-mail
- Policy settings for conflicted files and file type filter support
- Version control: up to 64 versions.
- Incremental synchronization for HDD space saving
- Unified privilege management
- Unified configuration management
- Support central configuration mode
- Support remote erase / restore
- Support shared folders sync
- Supports Windows & Mac OS

## Web Administration

- Multi-window, multi-tasking based system management
- Movable Icons and personalized desktop
- Smart toolbar and dashboard for neat system status display on system status
- Smart fan Control
- Dynamic DNS (DDNS)
- SNMP (v2 & v3)
- Resource monitor
- Network recycle bin for file deletion via CIFS/SMB, AFP, and File Station
  - Automatic Cleanup
  - File Type Filter
- Comprehensive logs (events & connection)
- Syslog client/server
- System settings backup and restore
- Restore to factory default
- Mobile app: Qmanager for remote system monitoring & management

## File Server

- File Sharing across Windows, Mac, and Linux/UNIX
- Windows ACL
- Advanced folder permission for CIFS/SMB, AFP, FTP
- Shared folder aggregation (CIFS/SMB)

## FTP Server

- FTP over SSL/TLS (Explicit)
- FTP support
- Passive ftp port range control

## File Station

- Support mount Cloud Drive (such as Google Drive, Dropbox, Microsoft OneDrive, Amazon Cloud Drive, Yandex Disk and Box)
- Support mount remote shared folder through FTP, WebDAV or Microsoft networking (SMB/CIFS)
- Supported open office document via Office Online, Google Docs or Chrome Extension (Edit Office files in Google Docs, Sheets, and Slides)
- Supports ISO Mounting (Up to 256 ISO Files)
- Supports thumbnail display of multimedia files
- Supported sharing download links and upload links
- Drag-n-drop Files via Google Chrome and Mozilla Firefox Browsers
- Photo, music, and video preview and playback with hardware-accelerated transcoding
- File Compression (ZIP or 7z)
- Creation of and sending download links for sharing public files with expiration time and password protection
- Support for displaying subtitles display (\*.SRT, UTF-8 format)
  - Video seeking support for video playback during on-the-fly transcoding
  - Support slideshow playback in media viewer
- Mobile App: Qfile for file browsing and management)

## Backup Station

- Remote replication server (over rsync)
- Real-time remote replication (RTRR) to another QNAP NAS or FTP server
- Works as both RTRR server & client with bandwidth control
- Real-time & scheduled backup
- Backup versioning for RTRR
- Encryption, compression, file filter, and transfer rate limitation
- Encrypted replication between QNAP NAS servers
- Desktop backup with QNAP NetBak Replicator for Windows
- Apple Time Machine backup support
- Data backup to multiple external storage devices
- Third party backup software support: Veeam backup & replication, Acronis True Image, Arcserve backup, EMC retrospect, Symantec Backup Exec, etc.

## Cloud Storage Backup

- Amazon S3
- Amazon Glacier
- WebDAV-based cloud storage
- Microsoft Azure
- Open Stack
- Google Drive
- Dropbox
- ElephantDrive
- Symform

## Print Server

- Max. number of printers: 3
- Support for Internet Printing Protocol
- Print job display and management
- IP-based and domain name-based privilege control

## Virtualization Station

- Support Virtual Machine (VM) creating to run an operating system such as Windows, Linux, Unix and Android
- Support VM import and export
- Support VM clone
- Support VM snapshot
- Support VM backup and restore
- VM console can be displayed via HDMI output - QVM
- HTML5-based shared remote console

## HD (HybridDesk) Station 3.0

- Playbacks videos, music, photos on your TV via XBMC xbmc via HDMI hdmi output
- Watch various online contents such as YouTube, Flickr, Picasa, Shoutcast, and more, etc.
- Web browser (Chrome, Firefox)
- Supports multi-nation keyboard, input and mouse
- Supports QNAP Qremote app and the official KODI remote app
- 4 new desktop themes
- Support user login permissions
- A variety of applications available such as Skype, Plex, Popcorn Time etc

## Signage Station

- Supports dynamic content including videos, images, music, and text messages
- Supports multi-users collaboration
- Supports searching via keywords,
- Supports sharing via email and social networks sharing
- Supports design software - iArtist Lite
- Supports account authority management
- Supports various web browsers for playback (Chrome, Firefox, IE, Safari)
- Supports most-viewed, latest-released and different categories content list

## iSCSI (IP SAN)

- iSCSI target with multi-LUNs per target (Up to 256 targets/LUNs combined)
- Support for LUN mapping & masking
- Online LUN capacity expansion
- Support for SPCC-3 persistent reservation
- Support for MPIO & MC/S
- iSCSI LUN backup, one-time snapshot, and restoration
- iSCSI connection and management by QNAP Windows Qfinder
- Virtual disk drive (via iSCSI initiator)
- Stack chaining master
- Max No. of virtual disk drives: 8

## Server Virtualization & Clustering

- Server Virtualization & Clustering
- VMware vSphere (ESXi 5.x)
- VMware VAAI for iSCSI and VAAI for NAS
- vSphere Plug-in
- Citrix XenServer (6.2)
- Windows Server 2012 R2 Hyper-V
- Supports Microsoft ODX
- QNAP SMI-S provider for Microsoft SCVMM

## Surveillance Station

- Supports over 2,100 IP ip cameras
- Includes 8 free camera licenses, up to 80 camera channels via additional license purchase
- Instant playback to check the recent events
- Online editing to change edit cameras when in live view
- Visual aid by using e-maps
- Playback and speed control by shuttle bar
- Video preview using on playback timeline
- Intelligent Video Analytics (IVAiva) for advanced video search
- Surveillance client for Mac
- Mobile surveillance app: Vmobile (iOS and Android)
- Mobile recording app: Vcam (iOS and Android)

## Notes Station

- A handy Note-taking tool for everywhere you go on your private cloud.
- Direct and quick backup from Evernote with re-editing availability
- Support Google Calendar
- Import/Export PDF file available

- RSS live feed and auto update
- Online quick preview multimedia attachments available
- Notes encrypt/decrypt available
- Smart snapshot for version control
- Background task available for multi-tasks users
- Collaborate notes with multi users
- Support graphical editor for note editing
- Three tiers Note structure for easy organizing
- Support keyword search
- Collaborate notes with multi users
- Provide Chrome Extension: Notes Station Clipper (Clip web page content to your note)

## VPN Server

- Secure remote access: PPTP - L2TP/IPsec & OpenVPN VPN services
- Max number of clients: 30

## VPN Client

- Supported VPN protocols: PPTP & OpenVPN services
- PPTP Authentication: PAP, CHAP, MS-CHAP, MS-CHAPv2
- PPTP Encryption: None, AES 40/128 bit, AES 256 bit
- OpenVPN Encryption: None, AES 40/128 bit, AES 256 bit
- Transmission package monitor
- OpenVPN port control
- OpenVPN link compression

## Domain Authentication Integration

- Microsoft Active Directory (AD)
- Domain controller
- LDAP server, LDAP client
- Domain users login via CIFS/SMB, AFP, FTP, and File Station

## AirPlay & Chromecast

- Streams videos, photos and music from the NAS to Apple TV via Qfile or QAirPlay&Chromecast's web-based controller
- Streams videos, photos and music from the NAS to TV with a Chromecast dongle via Qfile, Qvideo or QAirPlay&Chromecast's web-based controller

## App Center

- More than 100 official and community software add-ons (ex: Dropbox, Google Drive Sync, McAfee, WordPress, HappyGet II, etc.)
- Photo Station
- Music Station
- Video Station
- iTunes Server
- DLNA Server
- AirPlay: Streams videos, photos and music from NAS to Apple TV via Qfile or QAirPlay's web-based controller
- Digital TV Station
- Download Station
- HD Station + XBMC media player + Google Chrome

## Mobile Apps

- Qfile: iOS, Android, Windows Phone 8+
- Qfile HD: iPad version
- Qmanager: iOS, Android
- Qmusic: iOS, Android
- Qremote: iOS, Android
- Qget: Android
- Vmobile: iOS, iPad, Android

## PC Utilities

- Qfinder: Windows, Mac, Linux
- myQNAPcloud Connect: Windows
- Qsync: Windows, Mac
- NetBak Replicator: Windows
- QGet: Windows, Mac, Linux
- vSphere Client plug-in: Windows
- Qsnap: Windows

## Qcenter (NAS CMS)

- Multiple NAS monitoring
- Utilization history reports
- Unified configuration management
- Visual display reports
- Monitor NAS behind NAT router with Q' center Assistant
- Virtual appliances supported for Hyper-V and VMware

Design and specifications are subject to change without notice.



# TS-ECx80U R2 Turbo NAS series

NAS with built-in 10GbE SFP+ LAN Ports and 40GbE ready



Built-in Dual-port  
10GbE SFP+  
Network Adapter

◆ **Unified Storage, Backup & Sharing**

Provides a secure storage solution for data backup, file sharing and virtualization applications via iSCSI, CIFS and NFS, coupled with hardware-accelerated AES-256-bit Full NAS volume encryption for ensured security.

◆ **Breakthrough performance**

The TS-ECx80U R2 series to provide fast data transmission speeds and 10/40 Gigabit high speed networks.



TS-EC2480U R2



TS-EC1680U R2



TS-EC1280U R2



TS-EC880U R2

## QNAP Systems, Inc.

TEL : +886-2-2641-2000 FAX : +886-2-2641-0555 Email: [qnapsales@qnap.com](mailto:qnapsales@qnap.com)  
Address : 3F, No.22, Zhongxing Rd., Xizhi Dist., New Taipei City, 221, Taiwan

QNAP may make changes to specification and product descriptions at any time, without notice.  
Copyright © 2016 QNAP Systems, Inc. All rights reserved.

QNAP® and other names of QNAP Products are proprietary marks or registered trademarks of QNAP Systems, Inc. Other products and company names mentioned herein are trademarks of their respective holders.

AMD, the AMD logo, and combinations thereof are trademarks of Advanced Micro Devices, Inc.



**Netherlands (Warehouse Services)**

Email : [nlsales@qnap.com](mailto:nlsales@qnap.com)  
TEL : +31(0)107600830

**Germany**

Email : [desales@qnap.com](mailto:desales@qnap.com)  
TEL : +49-89-381562991

**China**

Email : [cnsales@qnap.com.cn](mailto:cnsales@qnap.com.cn)  
TEL : +86-400-628-0079

**India**

Email : [indiasales@qnap.com](mailto:indiasales@qnap.com)

**US**

Email : [usasales@qnap.com](mailto:usasales@qnap.com)  
TEL : +1-909-595-2782

**Thailand**

Email : [thsales@qnap.com](mailto:thsales@qnap.com)  
TEL : +66-2-5415988



P/N: 51000-023946-RS  
201601 (ENG) B